

Street map design standard

Issue 2



Contents



Foreword

1	Basic elements	2.10 Viewpoints	2.24 Building entrances
1.1	Typography	2.11 Pedestrian crossings	2.25 Multi-level areas
1.2	Colours (infolith and finder maps)	2.12 Pedestrian subways and covered walkways	2.26 Bridges and viaducts
1.3	Pictograms	2.13 Steps, lifts, ramps and barriers to pedestrian movement	2.27 Rail and line cuttings
1.4	Mapping scales	2.14 Underground, Overground, DLR, London Buses and National Rail stations	2.28 Rail over road names
2	Mapping elements for the infolith finder map	2.15 Bus stops and coach stops	2.29 Internal space
2.1	Villages and neighbourhoods	2.16 Cycle Hire stations	2.30 Campus buildings
2.2	Road names	2.17 River piers	2.31 Airport/terminal
2.3	Landmark buildings label	2.18 Ferry crossing	2.32 Prison buildings
2.4	Bespoke landmark buildings labels	2.19 Taxi ranks	2.33 Industrial buildings
2.5	3D buildings	2.20 Car parks	2.34 Hotel clusters
2.6	Monuments and landmark gates labels	2.21 Toilet facilities	2.35 Definition of building footprint
2.7	Areas of water	2.22 Information centres	2.36 Building numbers
2.8	Squares and gardens	2.23 Retail units	2.37 'You are here' marker and walking circle
2.9	Private gardens		

Continued...

Contents (continued)



- 2.38 Infolith extended walking circle
 - 2.39 North indicator
 - 2.40 Off-map tabs
 - 2.41 Index – Grid
 - 2.42 Index – Street finder
 - 2.43 Index – Landmark finder
 - 2.44 Index – key
 - 2.45 Copyright text for infolith maps
 - 2.46 Branding
 - 3 Mapping elements for the printed finder map**
 - 3.1 Colours (printed map)
 - 3.2 Matrix of changes for conversion
 - 3.3 Selected examples of printed finder map
 - 3.4 Copyright text for printed maps
 - 4 Mapping elements for the infolith planner map**
 - 4.1 Finder map window
 - 4.2 Villages
 - 4.3 Roads
 - 4.4 Landmark building labels
 - 4.5 Green spaces
 - 4.6 Areas of water
 - 4.7 Underground, Overground, DLR, London Buses and National Rail stations
 - 4.8 River piers
 - 4.9 Walking circle and ‘You are here’ marker
 - 4.10 North indicator
 - 4.11 Unique sign code
 - 5 Third party usage**
 - 5.1 Highlighting selected buildings
 - 5.2 Highlighting multiple locations on a map
 - 5.3 Highlighting selected routes
 - 5.4 Walking scale
 - 5.5 Branding maps on third party material
- Further information**



Transport for London (TfL) produces a wide range of street maps for customer information. This document details the graphical elements that go towards the construction of such maps and ensures that TfL has a consistent approach to the delivery of street map information.

TfL street maps fall into four types:

- Infolith finder maps
- Infolith planner maps
- Printed finder maps
- Printed planner maps

It should be clearly established before commencing work on a map whether the map is designed for printed use or Infolith use as the colour schemes for infolith maps differ from those of printed finder maps.

Please note that the rules within this standard are mandatory. No graphical element should be added to a TfL street map unless it is contained within this standard. If you believe there is good cause to include any additional graphic device to this standard then please contact TfL Corporate Design.

Telephone: **020 7126 1624**

Internal extension: **61624**

For more guidance on TfL Corporate standards, please visit the TfL website:
tfl.gov.uk/corporatedesign

1 Basic elements

Contents



This section of the document gives guidance on the basic elements that make up the TfL Street map design standard. The information covered includes the use of fonts, pictograms and colours.

Please note, all measurements referred to throughout this document are in millimetres.

Further detailed design information can be found in design standards available on the TfL website: tfl.gov.uk/corporatedesign

1.1 Typography

Contents



New Johnston

There are two typefaces used for TfL street maps. The primary typeface is the corporate font New Johnston. Bold, Medium and Light versions of the font are used on TfL street maps.

**ABCDEFGHIJKLMNOPQRSTUVWXYZ
abcdefghijklmnopqrstuvwxyz
1234567890£/.,“()::**
New Johnston Bold

**ABCDEFGHIJKLMNOPQRSTUVWXYZ
abcdefghijklmnopqrstuvwxyz
1234567890£/.,“()::**
New Johnston Medium

**ABCDEFGHIJKLMNOPQRSTUVWXYZ
abcdefghijklmnopqrstuvwxyz
1234567890£/.,“()::**
New Johnston Light

A b

1.1.1 Typography (continued)

Contents



Univers

The secondary font used on TfL street maps is from the Agfa Monotype Univers family. Univers 67 Bold Condensed and Univers 57 Condensed are the two versions of this font that are used for road names in order to maximise legibility.

ABCDEFGHIJKLMNOPQRSTUVWXYZ
abcdefghijklmnopqrstuvwxyz
1234567890£/.,"()::

Univers 67 Bold Condensed

ABCDEFGHIJKLMNOPQRSTUVWXYZ
abcdefghijklmnopqrstuvwxyz
1234567890£/.,"()::

Univers 57 Condensed

A b

1.2 Colours (infolith finder and planner maps)



Infolith finder and planner map palette

There are two colour palettes for TfL street maps. The colours shown here are those to be used for the infolith finder and planner maps.

A separate colour palette exists for the printed finder and planner maps and can be found in the 'Mapping elements for the printed finder map' section of this document.

Road base



C: 87
M: 46
K: 81

Pedestrian area



C: 53
M: 27
K: 31

Buildings

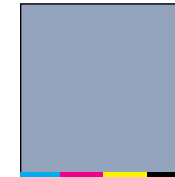

C: 26
M: 13
K: 24

Landmark buildings

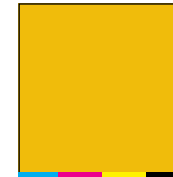

M: 22
Y: 100
K: 6

Water/parking

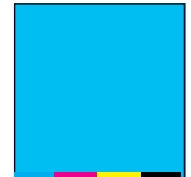

C: 75

Green areas

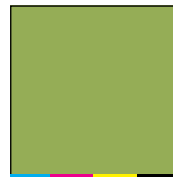

C: 40
M: 10
Y: 80
K: 10

Woodland areas



C: 50
M: 12
Y: 90
K: 25

Bus stops



M: 100
Y: 100
K: 6

Landmark labels



C: 87
M: 46
Y: 0
K: 81

Road/area names

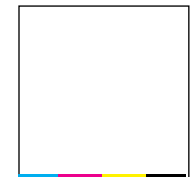

C: 0
M: 0
Y: 0
K: 0

Multi-level areas



C: 70
M: 44
Y: 22

Steps and barrier linework

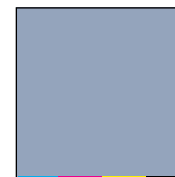

C: 26
M: 13
K: 24

Viaduct/rail base



C: 54
M: 27
K: 60

1.3 Pictograms



The only pictograms to be used on a TfL street map are those illustrated on the following pages. No additional pictograms are to be used without the permission of TfL Corporate Design.

Note that there are five categories of pictogram:

Finder maps

Category A - Landmark transport locations

These pictograms are designed to be used by pedestrians to identify key transport landmarks along a route. They are the largest pictograms to appear on a finder map, identifying Underground, Overground, DLR and National Rail stations. River piers, tram stops and coach stations are also identified by Landmark location pictograms.

Category B - Facilities

These pictograms are not used by the pedestrian to identify key landmarks on their route. However, they are considered to be important enough to be highlighted on the finder map as facilities that the pedestrian may seek out as part of their journey. Bus stops, Cycle Hire stations and taxi ranks all fall under this category as do toilets and car parking facilities.

Category C - Subsidiary entrances

Category C pictograms are the third tier of pictograms to appear on the finder maps. They are seen as helpful to pedestrians in deciding where to enter a facility.

These pictograms are never used in isolation. They always either accompany Category A pictograms, such as when displaying station entrances, or Facility pictograms, such as when displaying an entrance to a car park. They are also sometimes used to show an entrance to a building.

Category D - Retail frontage

These pictograms indicate clusters of local popular trade, reflecting activity and local identity. Although set at the same size as Category C pictograms, they differ in their appearance, always being displayed on a transparent background.

Planner maps

Category E - Landmark location pictograms

This is the only type of pictogram to be displayed on a planner map. As with the finder map version these pictograms, they are designed to assist the pedestrian pick out key transport stations on their route. The planner map landmark location pictograms, however are displayed at a smaller size to the Finder map versions of these pictograms.

Sizes for all pictograms are shown on the following pages.

1.3.1 Pictograms (continued)



London Underground station

Finder map
Category A - 10mm (h) 

Finder map
Category C - 5mm (h) 

Planner map
Category E - 5.5mm (h) 

Docklands Light Railway station

Finder map
Category A - 10mm (h) 

Finder map
Category C - 5mm (h) 

Planner map
Category E - 5.5mm (h) 

London Overground station

Finder map
Category A - 10mm (h) 

Finder map
Category C - 5mm (h) 

Planner map
Category E - 5.5mm (h) 



National Rail station

Finder map
Category A - 10mm (h) 

Finder map
Category C - 5mm (h) 

Planner map
Category E - 5.5mm (h) 

River piers

Finder map
TfL Operated
Category A - 10mm (h)  

Finder map
All other piers
Category A - 7mm (h) 

Planner map
TfL operated
and primary piers
Category E - 3.5mm (h) 

1.3.2 Pictograms (continued)



Other transport facilities

Bus station
Finder map
Category A - 10mm (h) 

Bus stop
Finder map
Category B - 6mm
(circle diameter) 

Bus station
Planner map
Category E - 5.5mm (h) 

Victoria Coach Station
Finder map
Category A - 10mm (h) 

Coach stop
Finder map
Category B - 6mm
(circle diameter) 

Victoria Coach Station
Planner map
Category E - 5.5mm (h) 

Cycle Hire station
Category B - 10mm (d)
(On Cycle Hire specific
maps diameter is 12.5mm) 

Tram stop
Finder map
Category A - 10mm (h) 

Tram stop
Planner map
Category E - 5.5mm (h) 

Taxi
Category B - 6.5mm (h) 

Car park
Category B - 6.5mm (h) 

Car park entrance
Category C - 4.3mm (d) 

Airport/terminal
Category A - 10mm (h)
Category E - 5.5mm (h) 

Information
Category B - 6.5mm (h) 

Non transport facilities

Male and female toilets
Category B - 6.5mm (h) 

Disabled toilets
Category B - 6.5mm (h) 

Baby changing
Category B - 6.5mm (h) 

24 hour toilets
Category B - 6.5mm (h) 

Building entrance point
(Flag shown to illustrate
dark keyline)
Category C - 4.6mm (d) 

Police station
(Flag shown to illustrate
dark background)
Category C - 10mm (w) 

Hospital (A & E)
Category B - 6.5mm (h) 

1.3.3 Pictograms (continued)



Non transport facilities (continued)

Post office
(Flag shown to illustrate
dark background)
Category C - 10mm (w)



Oyster ticket stop
Printed finder map
Category B - 10mm (h)



Lift
Category B - 6.5mm (h)



View point
Printed finder map
Category B - 5.5mm (h)



Retail

Shops
Category D - 5mm (h)



Gifts
Category D - 5mm (h)



Fresh produce
Category D - 5mm (h)



Clothes
Category D - 5mm (h)



Shoes
Category D - 5mm (h)



Cafes
Category D - 5mm (h)



Restaurants
Category D - 5mm (h)



Bars
Category D - 5mm (h)



1.4 Mapping scales

Contents



Although the OS master map data is surveyed at a scale of 1:1,250, the base master map should be set to a 1:2,250 scale for the finder maps and 1:1,500 for the planner maps.

Printed finder maps produced for double royal and quad royal posters should again be set to a 1:2,250 scale. Those produced for an A4 sized publication (or smaller) should be set to a 1:5,700 scale.

For sizes in between double royal and A4 the optimum scale is 1:2,250 and the minimum scale is 1:5,700.



The finder map is used to find a destination at any point within a journey. It shows many useful landmarks so that the user can be memorably guided towards specific streets and attractions.

The rules within this section of the document are the same for both the infolith finder map and the printed finder map.

Please note, however, that the colours displayed are for the infolith finder map only.

Detailed information for the printed finder map (including colour usage) can be found in the 'Mapping elements for the printed finder map' section of this document.

Guidance to application of standards

- Landmark labels should generally be white where they sit over large areas of either green space or pavement, or where they sit over combinations of these colours (the white label maintains clarity better where the background is noisy)
 - Using 6pt road names should be carefully considered so as to maintain maximum clarity whenever possible
 - Extensive usage of 6pt labels in a concentrated area can lead to the map becoming less legible - this therefore should be avoided
 - Guidance suggesting clear space between road names and pavement should be treated as just guidance, and not adhered to without careful consideration (in some cases it will be more appropriate to use a larger point size and overlap the text slightly for the purposes of clarity or consistency)
- Straight apostrophes and ligatures should not be used in any instance
 - 'Saint' must not be used, the abbreviated St. should be used with a full stop. No other abbreviations require a full stop

2.1 Villages and neighbourhoods

Contents



Villages are shown as upper case translucent names. As a default, the type size is 55pt, but there is a tolerance level of +/-20% to allow for optimum size/positioning on heavily congested sections of the map and/or extremely long/short names.

Neighbourhoods are shown at the fixed size of 25pt.

The opacity values for the villages and neighbourhoods are different to ensure an optical balance despite the size differential between the elements.

The example here shows the village of Marylebone and the neighbourhood of Manchester Square. As explained later within this document, squares are often identified as neighbourhoods. When this is the case, the neighbourhood name takes precedence and the standard square label is dropped.



Villages
Size: 55pt
Leading: 55pt
Typeface: NJFont Light
Case: Upper
Tracking: +200
Alignment: Centred
Opacity: 80%
Colour: C0-M0-Y0-K0

Neighbourhoods
Size: 25pt
Leading: 25pt
Typeface: NJFont Medium
Case: Upper & lower
Tracking: +100
Alignment: Centred
Opacity: 85%
Colour: C0-M0-Y0-K0

2.2 Road names

Road names are displayed in four different sizes, dependent on importance or size of road.

The largest 18pt type style is generally reserved for those roads that have been identified as linear neighbourhoods (for example Oxford Street, Regent Street etc). When space is too limited to fit a road name comfortably at this size, or if the road in question is simply a main road as opposed to a linear neighbourhood, the smaller 13pt type style can be used.



Major roads



Major roads (limited space)

Major roads
Size: 18pt
Typeface: Univers 57
Condensed
Case: Upper
Alignment: Centred
Tracking: +500
Colour: C0-M0-Y0-K0
Major roads (limited space)
Size: 13pt
Typeface: Univers 57
Condensed
Case: Upper
Alignment: Centred
Tracking: +500
Colour: C0-M0-Y0-K0

2.2.1 Road names (continued)

The majority of other road names will be 8pt, in the style identified here as 'Roads'. When space is too limited to fit a road name comfortably at this size, the smaller 6pt type style can be used or the name can be abbreviated; the smaller size should be used when it is an issue of height, abbreviations should be used when it is an issue of length. This rule applies to the use of the larger sizes also and standard abbreviations can be found in the appendix.

Road names can be duplicated along the length of the road if required for the purposes of clarity. Consideration should be given to ensure repeated names do not appear too close or too far apart from each other and cause unnecessary noise.

When road names are obscured by 3D buildings they should be placed as close as possible and used in conjunction with a line indicating the hidden road. As a rule the standard 'Road' style should be used.



Roads



Roads (limited space)

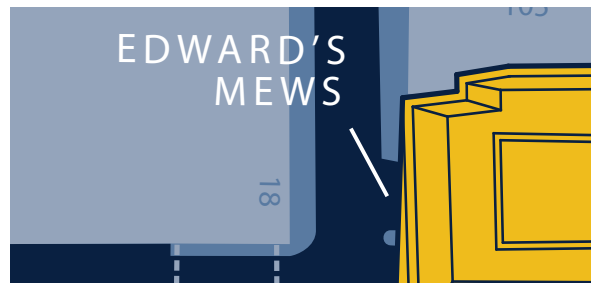

Obscured roads

Roads

Size: 8pt
Typeface: Univers 57
Condensed
Case: Upper
Alignment: Centred
Tracking: +150
Colour: C0-M0-Y0-K0

Roads (limited space)

Size: 6pt/Leading: 6pt
Typeface: Univers 57
Condensed
Case: Upper
Alignment: Centred
Tracking: +150
Colour: C0-M0-Y0-K0

2.3 Landmark building labels

Contents



Due to the nature of the high contrast map display two styles of labels are used for landmark buildings, designed to be legible across all possible colour combinations on the base map.

Dark labels should be used as the default in all cases unless it becomes necessary to run the text on top of the road base colour due to the limited size or rotation of the yellow building footprint. If this is the case a light version of the label should be used. Due to colour contrast issues, it should be placed so that only a minority of the label runs across the yellow building – just enough so it is clear which building the label refers to.

White labels consist of a white name placed on top of a pavement colour name which has a 0.75pt stroke, as shown in the example here.

Note

In some very busy areas of the map (eg Seven Dials and Leicester Square) the labels do not fit without running in to each other. For these specific areas the labels drop to 10pt. Permission must be sought from TfL Corporate Design before using labels at this point size.

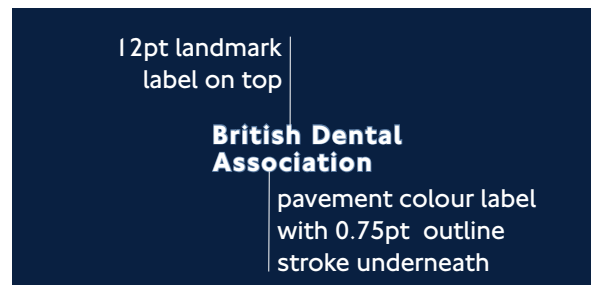

Composition of a white landmark label



White label with minimal overlap on yellow landmark

Dark building labels

Size: 12pt
Leading: 12pt
Typeface: NJFont Bold
Case: Upper & lower
Tracking: +50
Alignment: Left
Colour: C87-M46-Y0-K81
or C0-M0-Y0-K0

Light building labels

Size: 12pt
Leading: 12pt
Typeface: NJFont Bold
Stroke: 0.75pt (base layer only)
Case: Upper & lower
Tracking: +50
Alignment: Left
Colour: C0-M0-Y0-K0
Stroke colour: C53-M27-Y0-K31

2.4 Bespoke landmark buildings labels

Contents



Certain landmark buildings have their own bespoke labels in order to differentiate them.

Police stations use the 'Police' pictogram; and post offices the 'Post Office' Pictogram, in both instances the text must be centred.

Hospitals that have A&E facilities have an additional white 'H' out of red pictogram that is used in conjunction with the standard text label.



Hospital labels

Size: 12pt
Leading: 12pt
Typeface: NJFont Bold
Case: Upper & lower
Tracking: +50
Alignment: Left
Colour: C87-M46-Y0-K81

A+E Hospital pictogram



Police pictogram



Post office pictogram



1.5

2.5 3D buildings

Contents



Three-dimensional buildings are added to the map to both aid navigation and add interest. They are drawn with respect to their appearance according to the direction in which the map faces and are designed in most cases to fit directly on top of the 2D building footprint.

The criteria for when buildings are shown in 3D is based primarily around their usefulness as a landmark when navigating through the streets. Buildings are not featured as particular types, but for prominence or architectural merit. A shop with an easily identifiable frontage positioned at the corner of two streets will be a useful navigational feature and as such should be considered above other shops for rendering in 3D. There may also be occasions where a map area appears sparse and the criteria may be adjusted to show other buildings such as churches to add interest to an otherwise two dimensional map,



2D illustration style (example only)

3D building labels

Size: 12pt

Leading: 12pt

Typeface: NJFont Bold

Case: Upper & lower

Tracking: +50

Alignment: Left

Colour: C87-M46-

Y0-K81

2.5.1 3D buildings (continued)

Generally each 3D building should be drawn in scale to reality. However it is sometimes relevant to either enlarge the building to maximize impact on the map or perhaps adjust the proportions of the building to increase clarity. For example reducing the height of a very tall building to prevent other map elements from being obscured.

Due to their often complex appearance, labelling on 3D buildings needs to be done with care so type is not obscured by building detail. In many cases it is possible to find a place where lines and type do not clash to too great a degree, but in some instances yellow outlining may be required. This should be done by duplicating the label, adding a 3pt stroke yellow outline and placing it underneath the original label as shown here.

All 3D building must be approved by TfL Corporate Design before inclusion on a map.

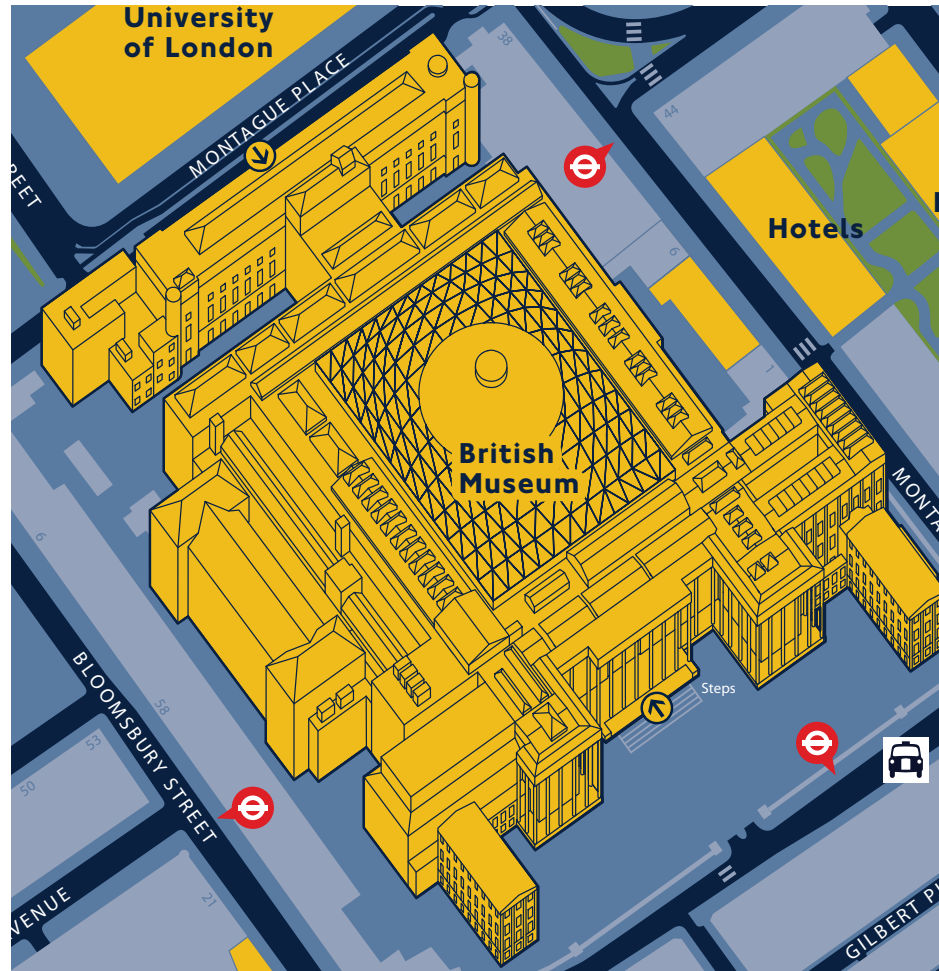

3D illustration style (example only)

3D building labels

Size: 12pt
Leading: 12pt
Typeface: NJFont Bold
Case: Upper & lower
Tracking: +50
Alignment: Left
Colour: C87-M46-
Y0-K81
Stroke: 3pt
Colour: C0-M22-
Y100-K6

2.5.2 3D buildings (continued)



Line weights and colours

Parallel lines should be no closer than 0.75pt to each other; this is to avoid clusters of lines merging when reproduced at actual size (there may be some limited occasions where it is appropriate to do otherwise, in such instances approval must be sought by TfL Corporate Design).

Where 3D buildings obscure road names, the name should be used as a label to identify the hidden road as shown in section 2.2.1. Where this does not sufficiently clarify the road position, the 3D building should be omitted or vertically re-scaled to clarify this issue. Any re-scaling must be subtle and not distort the overall appearance of the building.

Where buildings are featured in the immediate vicinity and the entrance points are unclear to the 3D projection, the building should revert to a two dimensional footprint.

Where the map crop results in a 3D building being significantly cut-off from the top or bottom, the 3D building should be omitted.

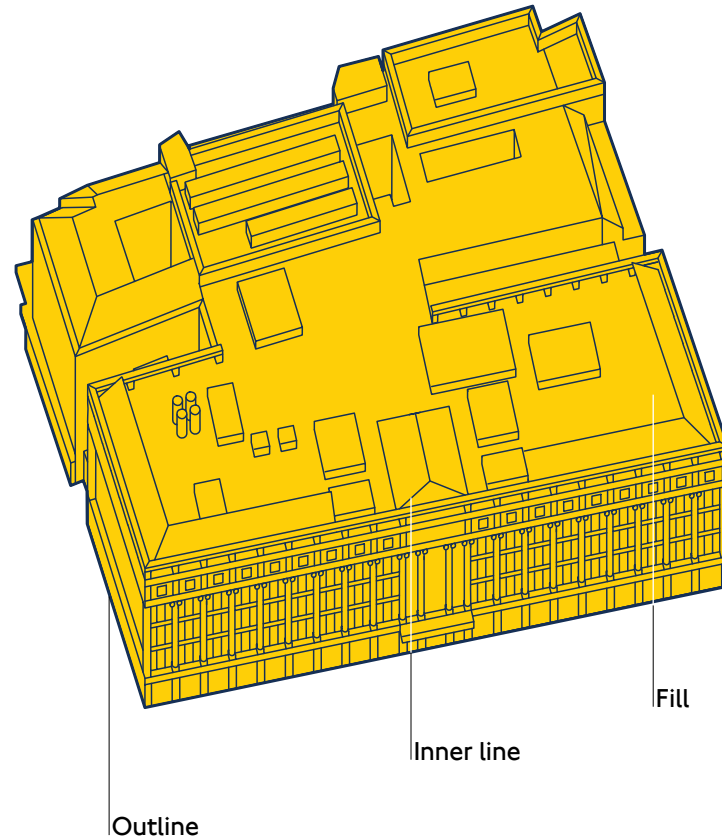

Outline
Stroke: 1pt
Colour: C85-M51-Y0-K90
Inner lines
Stroke: 0.5pt
Colour: C85-M51-Y0-K90
Fill
Colour: C0-M22-Y100-K6

2.5.3 3D buildings (continued)

Too much detail

In the example here (Centre Point), there are various problems concerning the level of detail in the illustration. The narrow edge of the tower actually has around 25 visible faces per floor of the building, which is far too many for the finished size of the illustration. The refined example has 8 faces per floor on the narrow edge, which is much clearer.

Parallel lines merging

Parallel lines merging is a common problem with the illustrations. As stated previously, parallel lines should be spaced at least 0.75pt apart wherever possible, otherwise lines will merge when printed, resulting in a visually noisy aggregation of lines. Every other vertical line was removed in the refined example, which resolves this problem acceptably.

Small features which cannot be simplified

If certain features are too small to be represented properly in print (eg if line merging occurs) and cannot be simplified, artistic license can be employed to exaggerate the size of the features. If this exaggeration is problematic (if there is no space) then these features should be deleted.

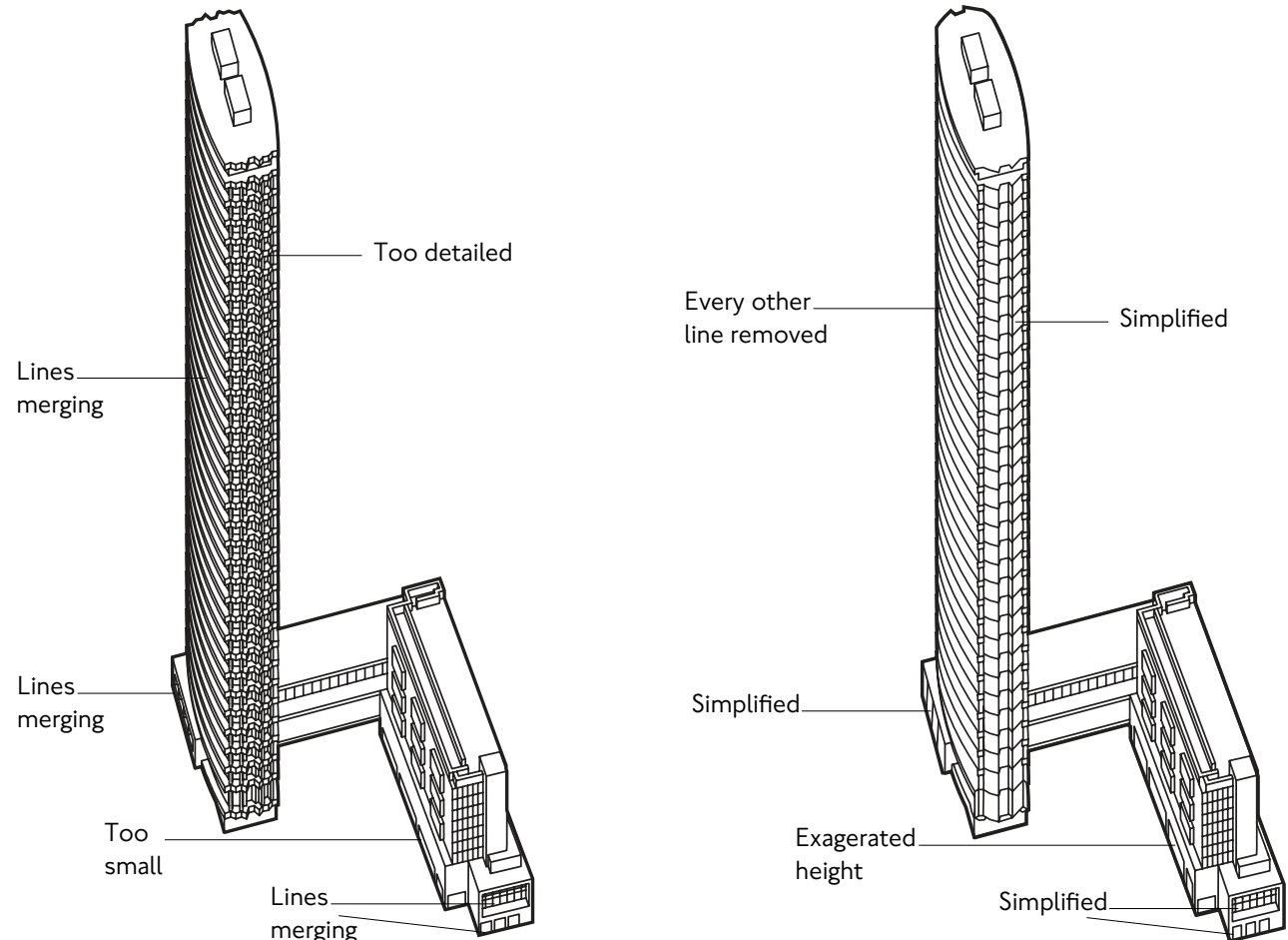

2.5.4 3D buildings (continued)

Shown here are other 3D building examples.
All views are North-up.

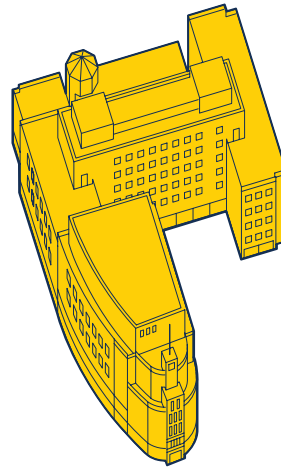

Burlington House

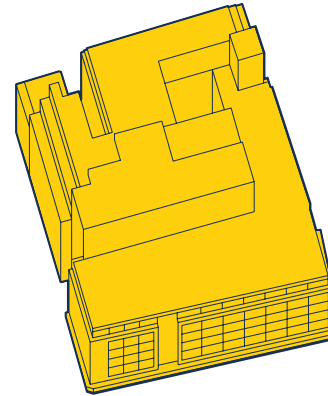

John Lewis

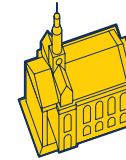

St George's
Hanover Square

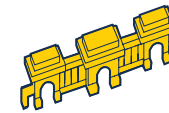

Apsley gate

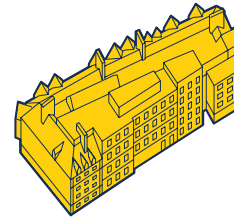

Liberty



Eros

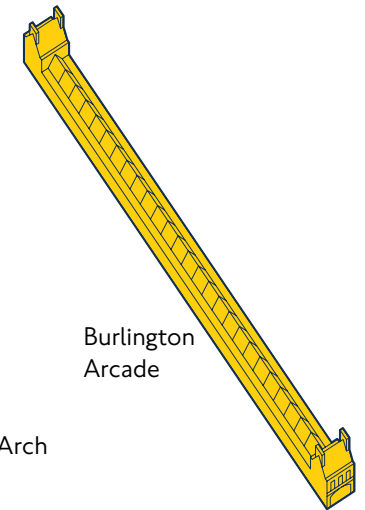

Burlington
Arcade



Marble Arch

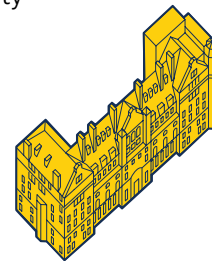

St Mary's Hospital

2.6 Monuments and landmark gates labels

Monuments and named or landmark gates are labelled according to the specification shown.

Any unnamed generic gates should not be labelled.



<u>Monuments/gates</u>
Size: 10pt
Leading: 10pt
Typeface: NJFont Light Italic
Case: Upper & lower
Alignment: Left & right
Tracking: +25
Colour: C0-M0-Y0-K0

Monument labels



Gate label

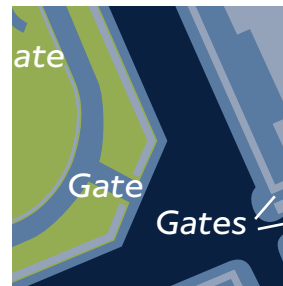

Example of generic gates which should be removed

2.7 Areas of water

Areas of water are labelled using one of two type styles.

The majority should be labelled using a 12pt style similar to that of squares or landmarks.

However, the River Thames should be labelled in a style more akin to a village name, as shown here. Like villages, there is a tolerance level of +/-20% to allow for optimum size/positioning.



Lakes and other smaller areas of water label



River Thames label

Lakes and other areas of water label
Size: 12pt
Leading: 12pt
Typeface: NJFont Bold
Case: Upper & lower
Alignment: Centred
Tracking: +50
Colour: C0-M0-Y0-K0
River Thames label
Size: 44pt
Leading: 44pt
Typeface: NJFont Light
Case: Upper
Tracking: +200
Alignment: Centred
Opacity: 80%
Colour: C0-M0-Y0-K0

2.8 Squares and gardens

Contents



All squares and gardens should be labelled using the type style shown.

In addition to squares and gardens this label style can be used to label any area of open space, large or small, paved or green, that requires marking.

Often squares are also identified as neighbourhoods – on such occasions, the larger neighbourhood name takes precedence and the 12pt square name is dropped.

In these instances the road names should still be shown on two opposite sides of the square.



An example of a square/garden label in use



Squares are often identified as neighbourhoods. The neighbourhood label takes precedence over the square label.

Squares & gardens

Size: 12pt

Leading: 12pt

Typeface: NJFont Bold

Case: Upper & lower

Alignment: Centred

Tracking: +50

Colour: C0-M0-Y0-K0

2.9 Private areas



Green spaces are key to wayfinding, regardless of whether they offer public access. They are also potential destinations for pedestrians, who may therefore find it useful to know which are private.

Representation of private gardens should highlight them as green spaces, whilst clearly indicating that they are not open to public access.

Private roads with no public access should display 'No public access'.

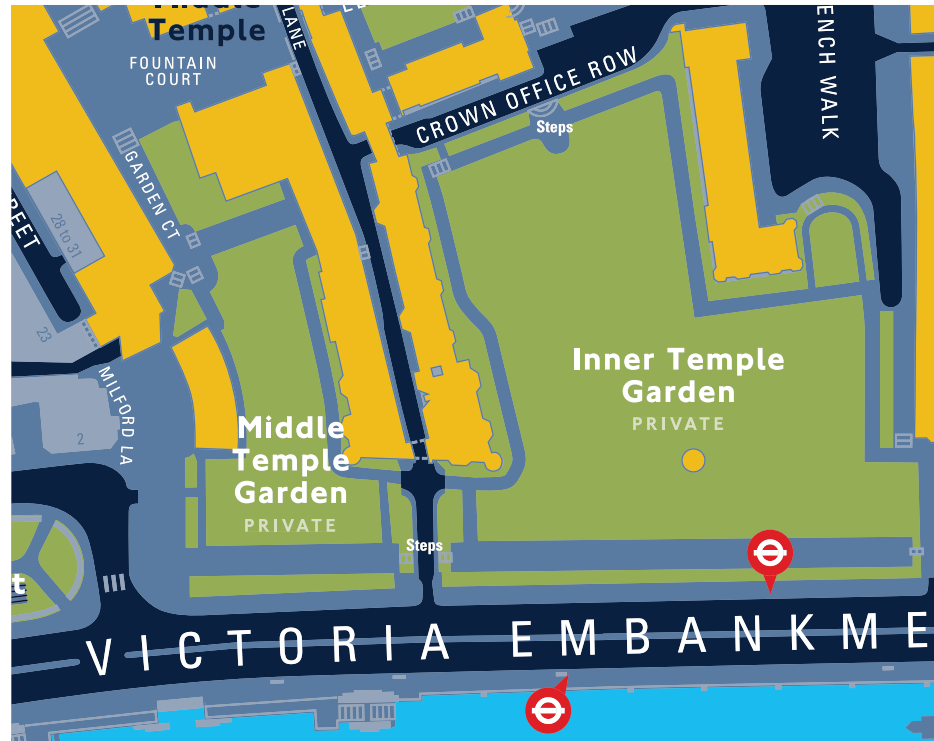

'Private' areas label
Size: 7pt
Leading: 12pt
Typeface: NJFont Bold
Case: Uppercase
Tracking: +50
Alignment: Centred
Colour: C0-M0-Y0-K0
Opacity: 70%

2.10 Viewpoints

Contents



Viewpoints shown on maps should be limited to high open areas, eg Parliament Hill, Primrose Hill, Royal Observatory Greenwich, rather than views from a street level. These vantage points should be depicted using the appropriate pictogram.

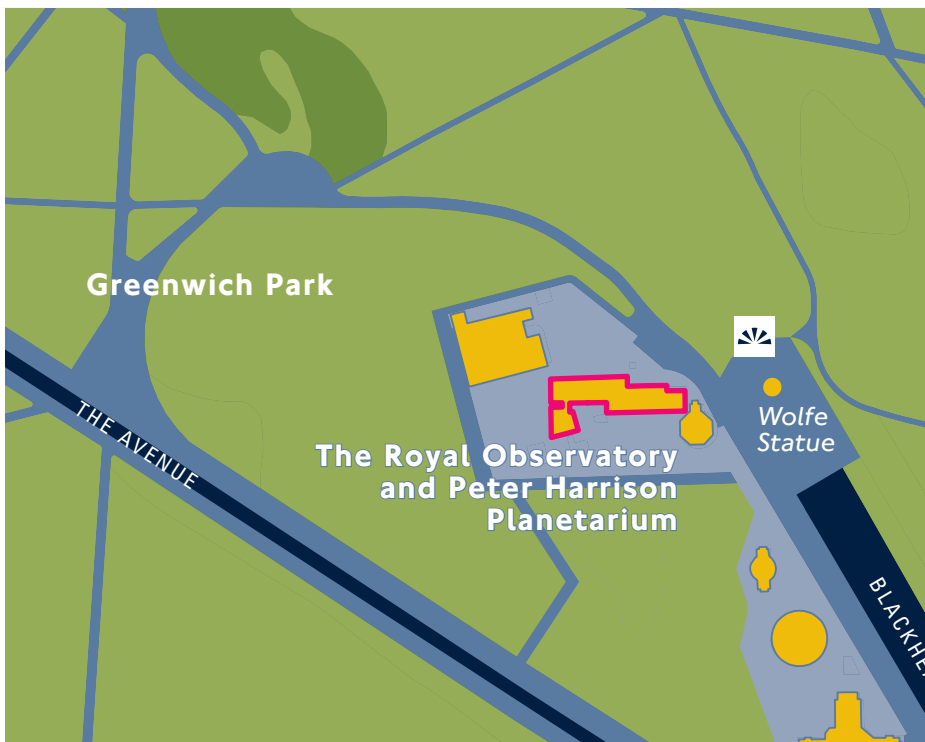

2.11 Pedestrian crossings

Contents



All pedestrian crossings are to be depicted by a dashed line as per the specification shown.

Crossing paths should be as clear and identifiable as possible. Minor street islands can be removed or simplified, if doing so increases clarity.

Care should be taken to space the crossings carefully to ensure they appear as parallel as possible to the pavements. If necessary, the amount of dashes used in the crossing should be reduced and the line centred in the space as shown.

NB: Source data for crossings is not complete and in some cases unreliable. Only crossings included in the UKMap data should be used. In addition, field checks will be carried out on crossings in locations which are not immediately obvious ie those not on main roads/at junctions.



Pedestrian crossing paths

Weight: 6pt
Dash line: 1.5pt
dash/1.5pt gap, butt cap
Colour: C26-M13-Y0-K24

2.12 Pedestrian subways and covered walkways



Pedestrian subways are shown with a 0.75pt dashed line and should join to steps/ramps at entrance points. They should also be labelled as shown.

Completely accurate rendering of the subway layout is not required and in some cases it is useful to adjust the subterranean routes in order to avoid at grade map elements such as crossings/covered walkways that could get confused.

Covered walkways are shown by two 0.75pt dashed lines spanning the pedestrian route under buildings or other structures, with the lines positioned at the extremities of the building/overhead structure.

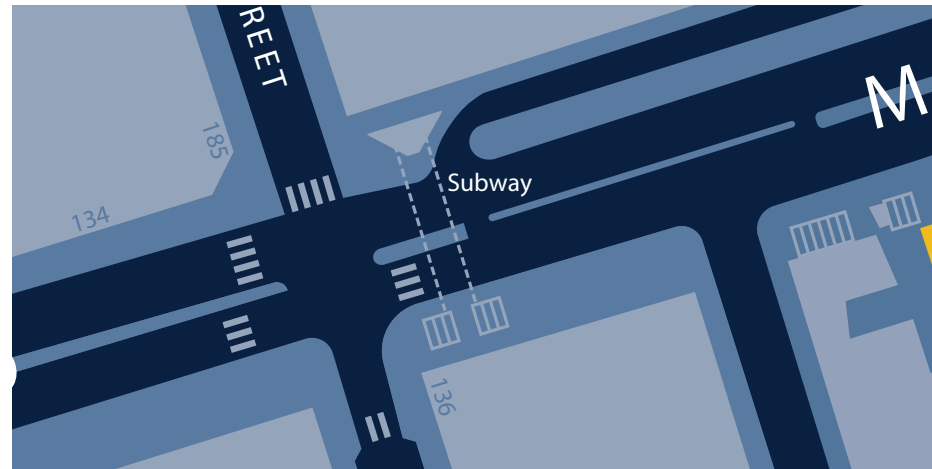

Pedestrian subway



Covered walkways



Pedestrian subway

Weight: 0.75pt
Dash line: 2pt dash/
1pt gap
Colour: C26-MI3-Y0-K24

Pedestrian subway label

Size: 8pt
Typeface: Univers 67
Bold Condensed
Case: Upper & lower
Alignment: Left & right
Colour: C0-M0-Y0-K0

Covered walkways

Weight: 1pt
Dash line: 2pt dash/
1pt gap
Colour: C26-MI3-Y0-K24

Over buildings

Weight: 1pt
Dash line: 2pt dash/
1pt gap
Colour: C53-M27-Y0-K31

2.13 Steps, lifts, ramps and barriers to pedestrian movement

Steps are indicated with a device made up of adjacent rectangles that are evenly spaced. As a rule there should always be a minimum of three steps (four lines) and the lines that indicate the steps should be a minimum of 0.75pt apart. Steps should be labelled when they are part of publicly accessible routes but do not have to be labelled at entrances to landmarks, tube stations or car parks for example, unless they are used to clearly define them from alternative accessible entrances. This will need to be considered on a case by case basis.

Lifts are indicated by a simple outlined 2pt outlined box as shown in the examples and can either be labelled or used in conjunction with a pictogram if relevant. Ramps are indicated by drawing the barriers either side of a ramped area and again are labelled like steps and lifts.



Standard steps

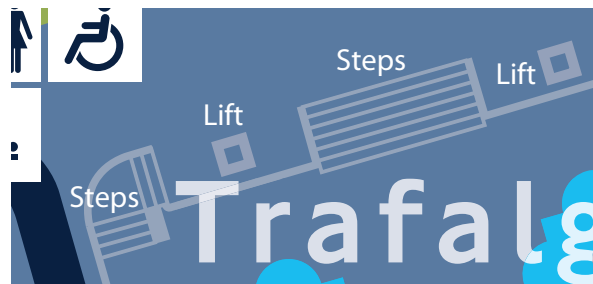

Bespoke steps and lift labels



TfL lift pictogram

Steps

Weight: 0.75pt
Stroke spacing:
minimum 0.75mm
apart.
At least three steps
must be shown.
Colour: C26-M13-Y0-
K24

Lifts

Size: 2.5mm x 2.5mm
Stroke weight: 2pt
Colour: C26-M13-Y0-
K24

2.13.1 Steps, lifts, ramps and barriers to pedestrian movement (continued)

Barriers to pedestrian movement are items such as fences, walls, railings etc. Barriers above waist height are shown using a 2pt line, while those at waist height and below are identified with a 0.75pt line. As a rule, standard guard railings are not drawn - the device is reserved for more important elements that help define the urban form.

Ramps are indicated by drawing the barriers either side of a ramped area and again are labelled like steps and lifts.



Ramps



High barriers to pedestrian movements



Low barriers to pedestrian movements

Steps/Lifts/Ramp label

Size: 6pt
Typeface: Univers 67
Bold Condensed
Case: Upper & lower
Alignment: Left & right
Colour: C0-M0-Y0-K0

High barriers to pedestrian movement – High fences/walls and impassable barriers

Weight: 2pt
Colour: C26-M13-Y0-K24

Low barriers to pedestrian movement – Railings and walls at waist height and below

Weight: 0.75pt
Colour: C26-M13-Y0-K24

2.13.2 Steps, lifts, ramps and barriers to pedestrian movement (continued)

Contents



Often steps, ramps, lifts and barriers are combined to represent useful detail in an area or explain changes of level or pedestrian access. However, whilst it is useful to draw such areas accurately to aid the user, it is important to keep the meaning of all graphic elements as clear as possible. With this in mind it is often best to use the standard steps device, simply adjusted to fit the respective space correctly, without the need to redraw in order to represent curves, spirals or other shapes.

The exception to this would be if in not doing so you would be omitting an important architectural feature or urban form. The example of Trafalgar Square here is a good one as just the right level of details are shown and elements are clearly labelled to clarify meaning.

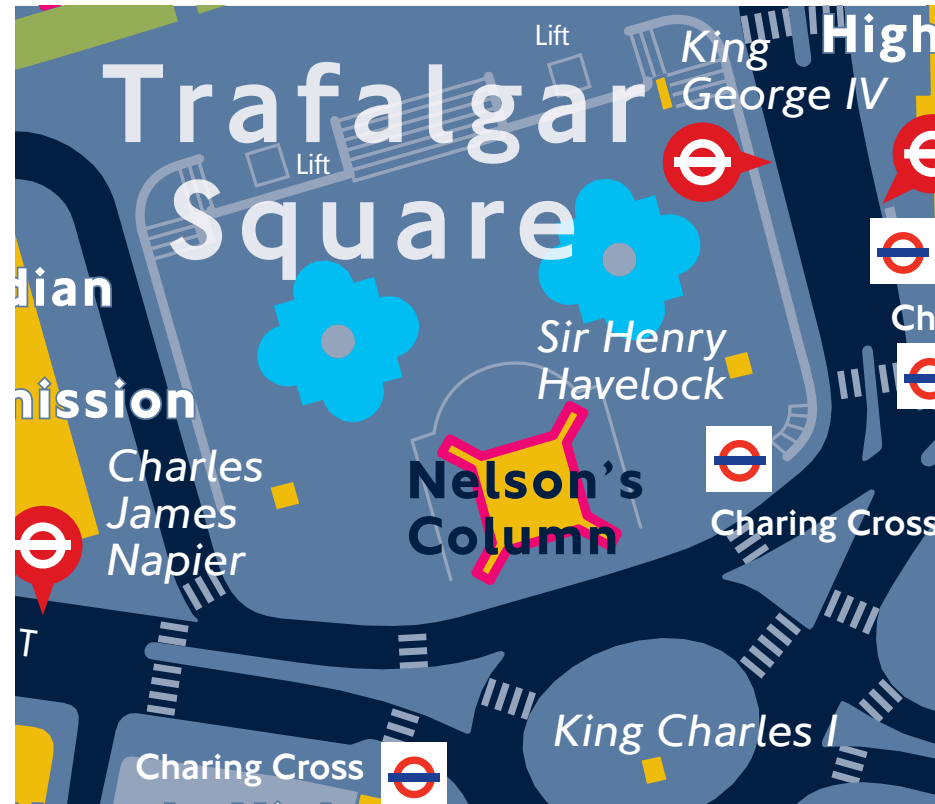

2.14 Underground, Overground, DLR, London Buses and National Rail stations and National Rail stations

Underground, Overground, DLR, London Buses and National Rail stations should be indicated with a 10mm pictogram (or pictograms, dependent on services offered) and its name.

The 10mm pictogram (or pictograms) should act to show where the main entrance/cluster of entrances occurs. A subsidiary smaller entrance pictogram may be required when an entrance is significantly detached from the main entrance/building. This occurs when the entrance in question is divorced from the main station device, or building footprint where applicable, by a busy intersecting road or other such major barrier to pedestrian movement.

Entrance pictograms consist of a smaller 5mm version of the main pictogram and are accompanied by a small label repeating the station name.

Refer to **Section 3.3.2** for numbered exits on printed maps.



Blackfriars



Oxford Circus – No subsidiary entrance pictograms are required

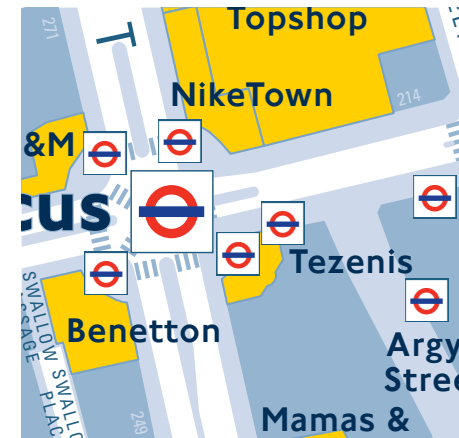

Oxford Circus – subsidiary entrance pictograms may be shown on some products

Main station name
Size: 25pt
Leading: 25pt
Typeface: NJFont Bold
Stroke: 0.75pt (base layer only)
Case: Upper & lower
Tracking: +20
Colour: C0-M0-Y0-K0
Colour: C53-M27-Y0-K3
Subsidiary entrance name
Size: 8pt
Leading: 8pt
Typeface: NJFont Medium
Case: Upper & lower
Colour: C0-M0-Y0-K0

2.14.1 Underground, Overground, DLR, London Buses and National Rail stations (continued)

All station names are outlined, as shown here, to ensure legibility across map colours. The labels consist of a white name placed on top of a pavement colour name which has a 0.75pt stroke, as shown here.

Many stations offer more than one service. Representative pictograms should be grouped (preferably) horizontally with 2mm between them. The different pictograms should be ordered in the sequence shown here

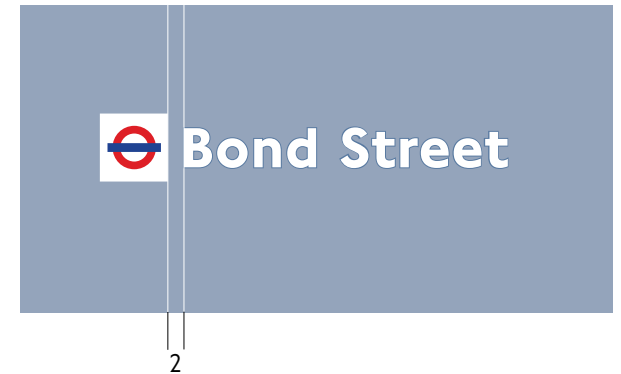
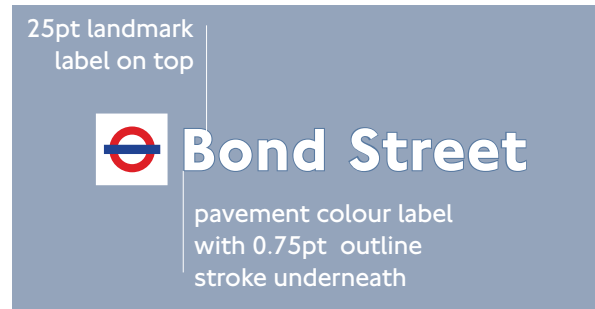

Each mode of transport is displayed in the above order

2.15 Bus stops and coach stops

Bus and coach stop pictograms, when required, are added to illustrate bus and coach stops along any given street or road.

The pictogram should be placed so that the pointer is perpendicular to the road, unless there are other map elements in the way. In such a case, the pointer can be rotated around the roundel and the pictogram moved to avoid overlapping elements.



The pointer should be rotated around the edge of the circle to accurately highlight the position of the stop. Where possible, a rotation perpendicular to the road should be utilised, avoiding overlapping with other mapping elements.

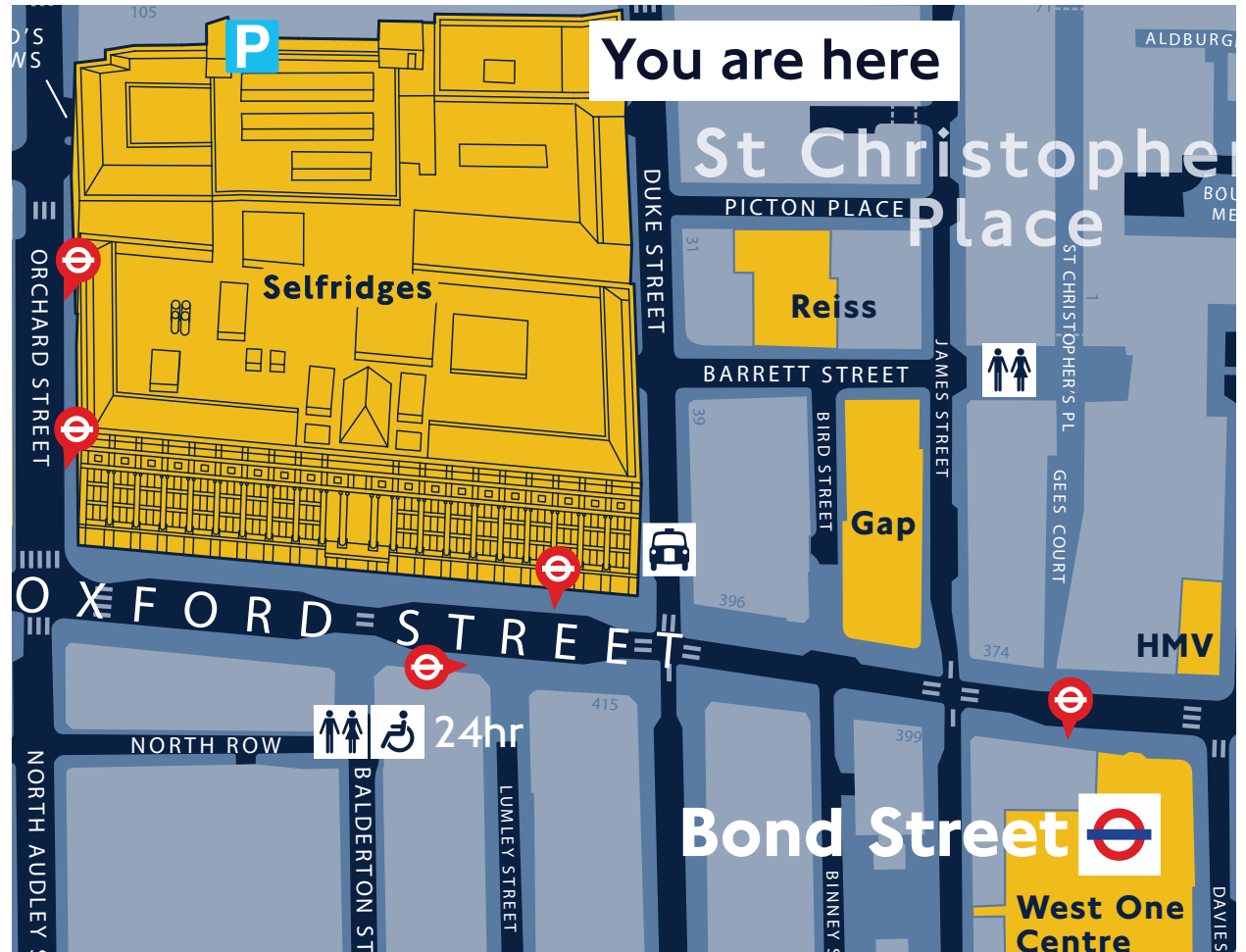

2.16 Cycle Hire stations

Where Cycle Hire pictograms are added to illustrate Cycle Hire stations they are to be displayed as shown.

The pictogram should be placed so that the pointer is perpendicular to the road, unless there are other map elements in the way. In such a case, the pointer can be rotated around the roundel and the pictogram moved to avoid overlapping elements.

Note

The standard diameter size of the circle for this pictogram is 10mm. On Cycle Hire specific maps the diameter is 12.5mm.



The pointer should be rotated around the edge of the circle to accurately highlight the position of the Cycle Hire terminal. Where possible, a rotation perpendicular to the road should be utilised, avoiding overlapping with other mapping elements.



Cycle Hire pictogram drop shadow

Mode: Multiply
Opacity: 80%
X Offset: 0.75mm
Y Offset: 0.75mm
Blur: 0.75mm
Colour: C0-M0-Y0-K100

2.17 River piers

Both primary and secondary piers are shown on TfL street maps. Primary piers offer a level of service approved by TfL whereas secondary piers do not provide such a service (contact TfL Corporate Design if in doubt as to whether a pier meets this criteria).

Primary piers are illustrated with a 7mm high boat pictogram.

Primary piers operated by TfL are shown with the addition of a 10mm London River Services roundel and boat pictogram. As with stations, the 10mm roundel pictogram should show where the main entrance/cluster of entrances occurs. It is not envisaged that subsidiary entrance pictograms will be needed.

Non-TfL operated piers should be depicted with the boat pictogram at a height of 7mm and the pier name.

Secondary piers do not display a boat pictogram. They simply show the pier name label at 12pt.



TfL operated primary pier



Non TfL operated primary pier

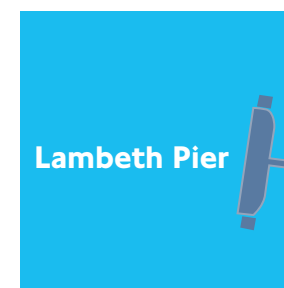

Secondary pier

2.17.1 River piers (continued)



Spacing of the elements that identify a river pier are illustrated here.

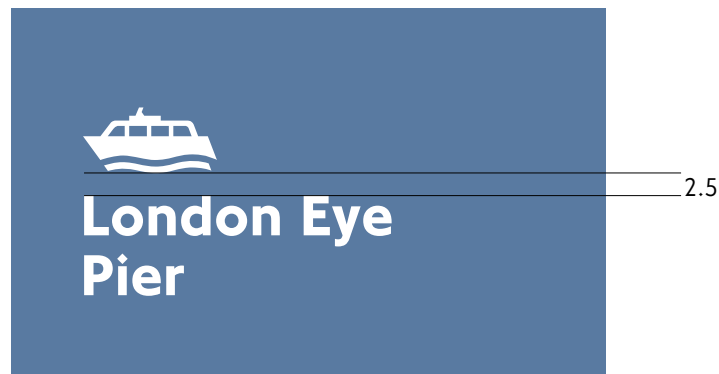
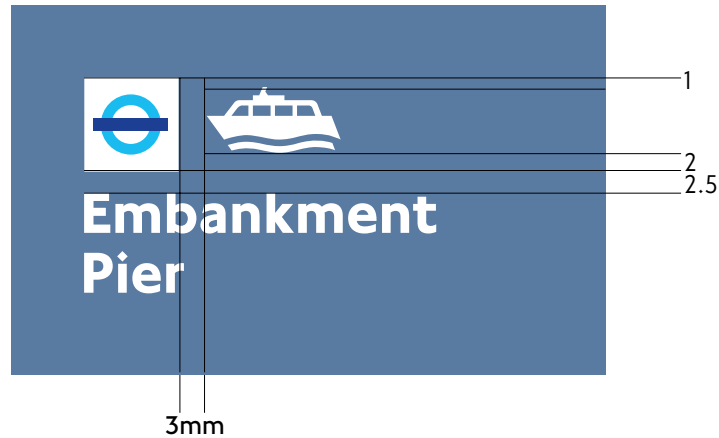

Primary pier label

Size: 18pt
Leading: 18pt
Typeface: NJFont Bold
Case: Upper & lower
Colour: C0-M0-Y0-K0

Secondary pier label

Size: 12pt
Leading: 12pt
Typeface: NJFont Bold
Case: Upper & lower
Colour: C0-M0-Y0-K0

2.18 Ferry crossings

Ferry crossings are shown by a dashed line indicating the route. This is in contrast to longer routes along the river which are indicated by pier symbols.

Piers are denoted with river pictograms, the name of the ferry must be written as close to the route line as possible and centrally placed rather than repeated.

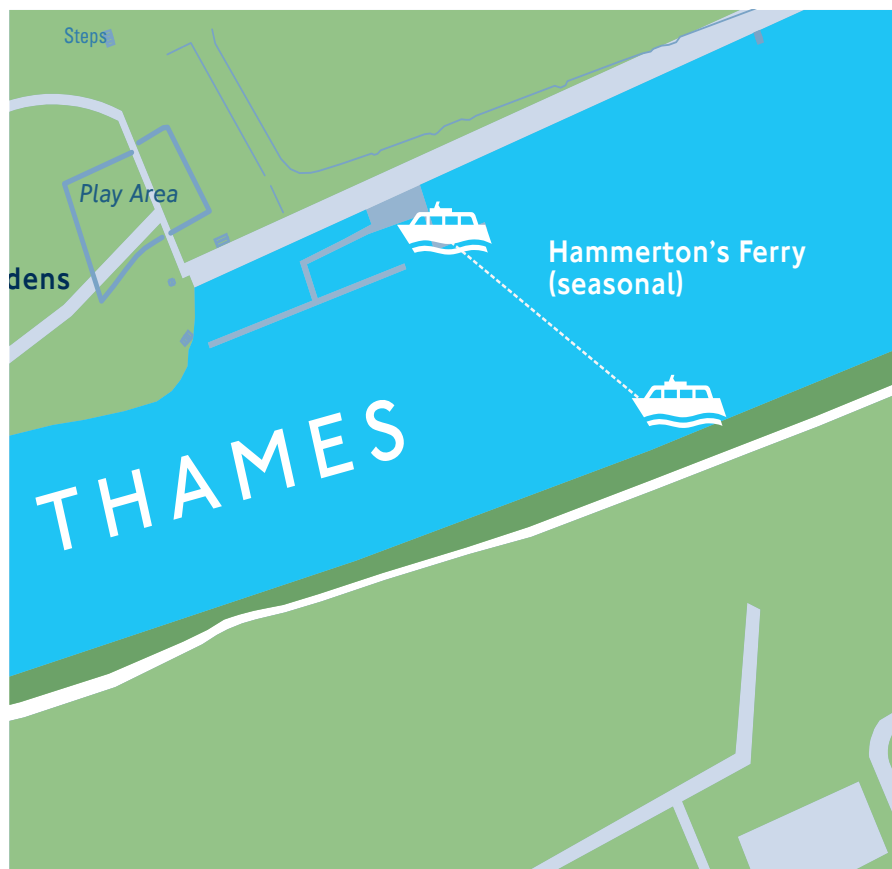

Example of ferry crossing

Ferry crossing label

Size: 12pt
Leading: 12pt
Typeface: NJFont Bold
Case: Upper & lower
Colour: C0-M0-Y0-K0

Ferry crossing line

Stroke 1pt
Dash: 2pt/2pt
Colour: C0-M0-Y0-K0

2.19 Taxi ranks

Contents



All taxi ranks are highlighted on the map.
Taxi stands should not be marked.

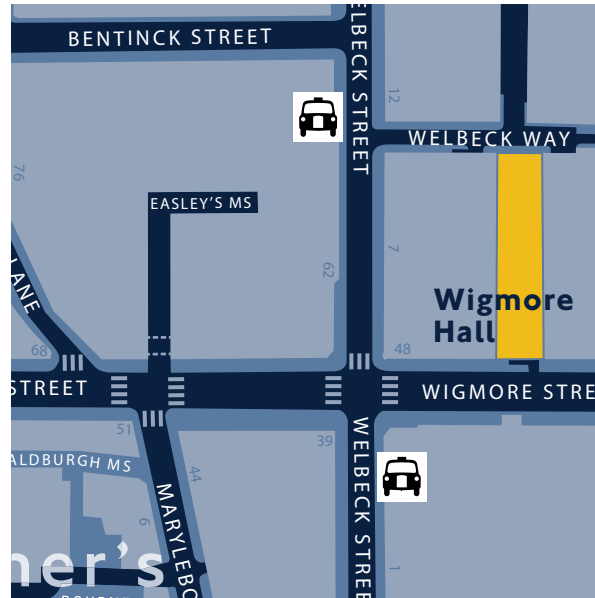

2.20 Car parks

Car parks are indicated on the map by the use of the universally recognised parking pictogram.

When the car park is an indoor facility it is shown simply as the building it is within, as shown. If it is an underground facility it is marked with the pictogram only, in the most appropriate place above the car park.

When the car park is an outdoor facility it should be represented by using the road colour. In addition to this, some extra simple detail can be added to help define and explain the space, for example, prominent parking bay divisions.

Data for this can be sourced initially from the original OS data and supplemented with checks on aerial photography to help define the optimum level of additional detail required.



Example of an indoor car park

2.20.1 Car parks (continued)

On some occasions, due to either the distance between a car park and its street entrance, the complexity of the space, or if the car park is underground, the position of the entrance may not be obvious to the user just by identifying the parking symbol. In these cases an additional entrance pictogram can be used to clarify the situation, though these should be used sparingly to avoid excessive map clutter. In addition, the entrance should be depicted as 2.1.8.1 pedestrian only and not a vehicle entrance.



Example of an outdoor car park, with pedestrian entrance identified and parking bay marking details

2.21 Toilet facilities

Pictograms are used to indicate male/female, disabled and baby changing facilities on the map. In each case the male/female pictogram should be used, either on it's own or in conjunction with one or both of the other pictograms and/or text.

When the facility has 24 hour access, this is shown using a 12pt label. General opening times, if not 24 hour are not shown.

When the facility is indicated by more than one pictogram, certain layout conventions apply to the grouping as shown here. The optional layout conventions can help with accurate placement, especially in congested areas of map.

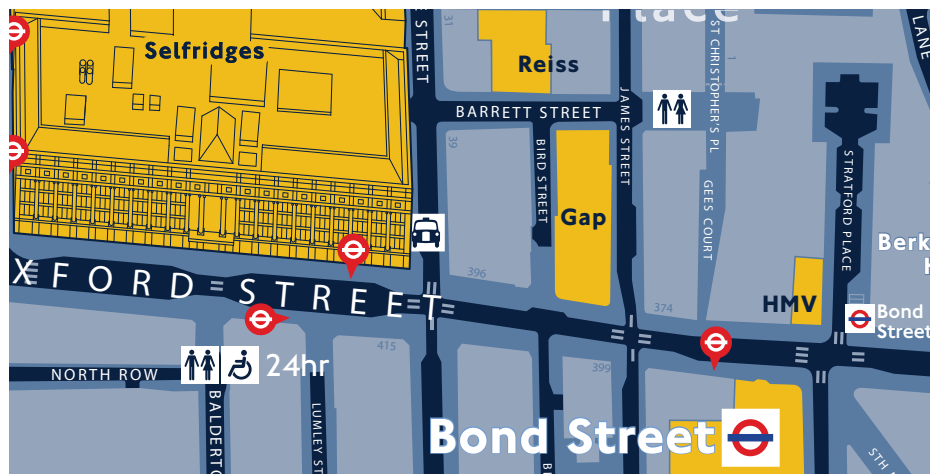

Groups of pictograms can be composed in either a line or can be stacked, in the ways shown above

2.22 Information centres

Both Travel Information Centres and Tourist Information Centres should be represented using the standard boxed 'i' pictogram.

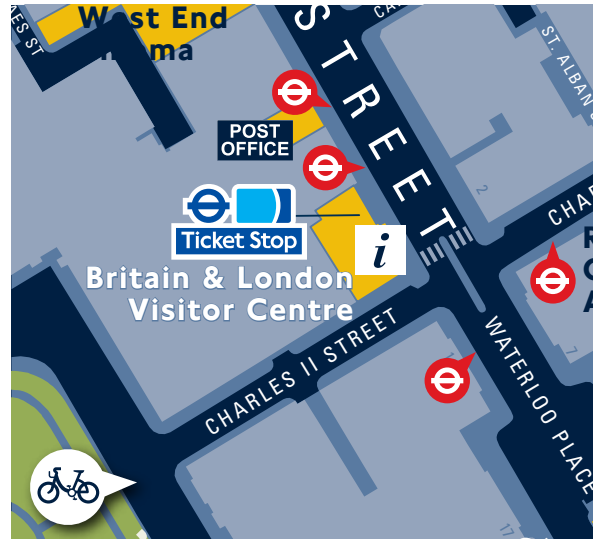

Example of the information 'i' pictogram

Information centres label
Size: 12pt
Leading: 12pt
Typeface: NJFont Bold
Case: Upper & lower
Colour: C0-M0-Y0-K0
Information 'i' pictogram
Size 6.5mm (h)

2.23 Retail area

Retail area pictograms are used for indicating clusters of local popular trade on the finder map – reflecting activity and local identity.

The label consists of a combination of text and up to four graphic pictograms.



As shown in the examples, the textual component can be either name or description, or both. For instance, where the label marks the trade present in a neighbourhood, it is useful to repeat the name (for identity and scale) and add a description (for specificity).

Elsewhere, retail unit labels can incorporate either just the area name or a description to broadly support the pictograms.

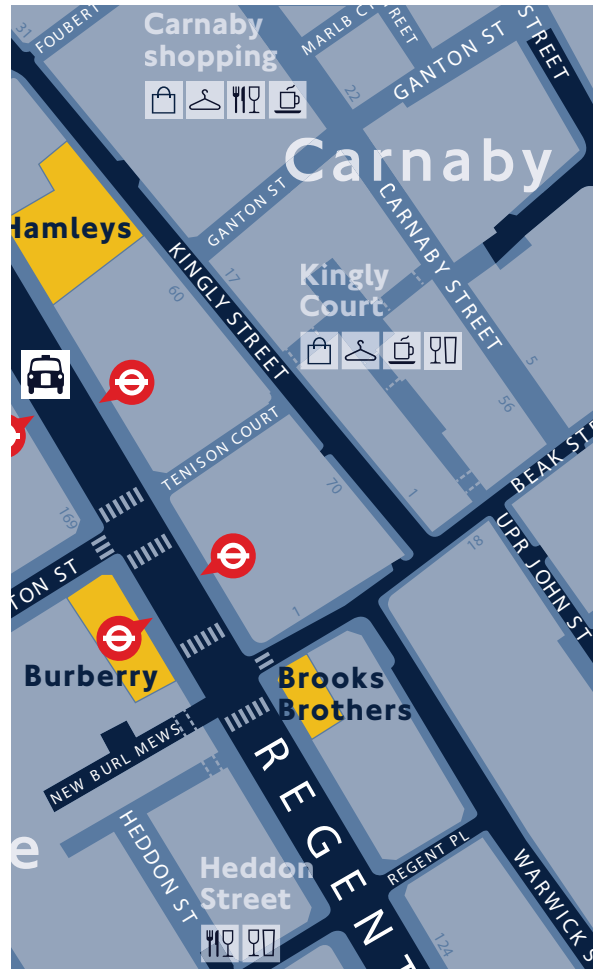
Market names should be indicated using retail area text with associated symbols. Where market names are used as neighborhood names the retail area text should be omitted and symbols positioned below the name



2.23.1 Retail units (continued)

Pictogram meaning	Retail unit sequence	Examples
 Shops		
 Gifts	<ul style="list-style-type: none"> No more than 4 pictograms should be used The pictograms should always be presented in the order shown here 	
 Fresh produce		
 Clothes		
 Shoes		
 Cafes		
 Restaurants		
 Bars		
	<p>Spacing</p> <p>St Christopher's Place shopping 2.5</p> <p> 0.5</p>	<p>St Christopher's Place shopping</p> <p></p> <p>Kingly Court</p> <p></p> <p>Shops and cafés</p> <p></p> <p>Borough Market</p> <p></p> <p>Old Compton Street</p> <p></p>

Retail unit text

Size: 12pt
 Leading: 12pt
 Typeface: NJFont Bold
 Case: Upper & lower
 Tracking: +10
 Alignment: Left
 Opacity: 70%
 Colour: C0 M0 Y0 K0

Retail unit pictograms

Alignment: Left
 Opacity: 70%
 Colour: C0 M0 Y0 K0

2.24 Building entrances

A pictogram to suggest entrances is available for use on selected buildings.

Entrances to buildings should be indicated if:

- The building is large, complex and/or has multiple entrances, or if time is a factor for the pedestrian, such as visitor attractions, stations and hospitals
- The building entrance is hidden or not in the obvious place (eg at the front)

Entrances to department stores should not be shown as these are generally obvious upon arrival and well supported. They could also be subject to regular change.

The entrance pictogram should be rotated to suggest the direction of travel through the entrance (into, not out of, the building).

When applied to 3D building illustrations, building entrance pictograms should be applied in the same way as when applied to a 2D building. However, on some occasions an entrance may be obscured by the illustration. As shown, these should be included wherever possible, working with the illustration to maximise usability.

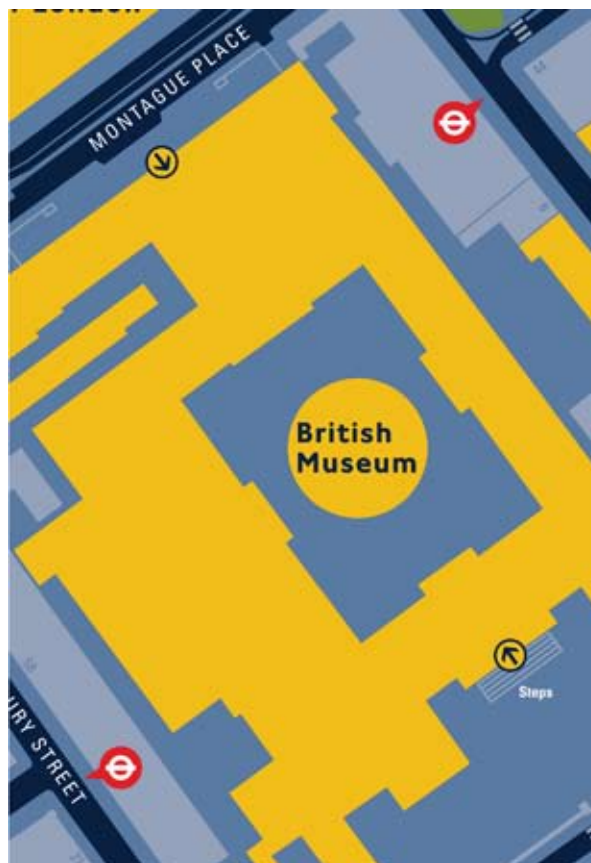

The British Museum with building entrances, as it would appear if shown in 2D

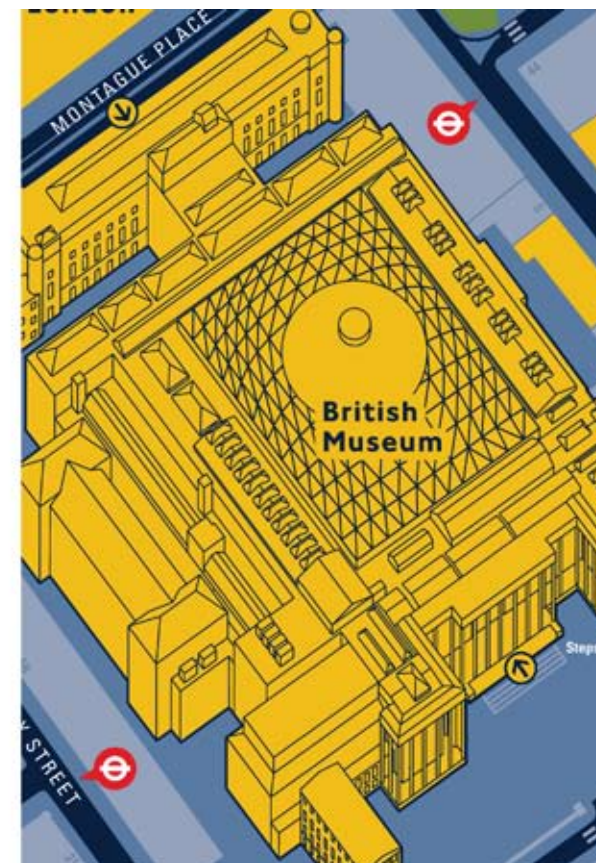

The British Museum with building entrances, as it would appear if it was shown as a 3D building (note: 3D building not finalised)

2.25 Multi-level areas

London has several areas where multi-level areas are an important part of the urban form and are important to show clearly in relation to other pedestrian areas and landmarks. When showing them on the map the following guidance should be followed, with in depth field surveys of the areas required prior to resolving the simplified graphic representation:

- 1 Pedestrian routes that go under bridges/ structures are defined with a dashed line as per the specification of subways (0.75pt). Labels can be added if necessary
- 2 Complex steps should be simplified and standardised where possible
- 3 Raised walkways that are above ground level have a new colour (C70-M44-Y22-K0), and gain a drop shadow
- 4 Raised walkways and the related landmark buildings should have their footprints simplified to optimise clarity of complex spaces

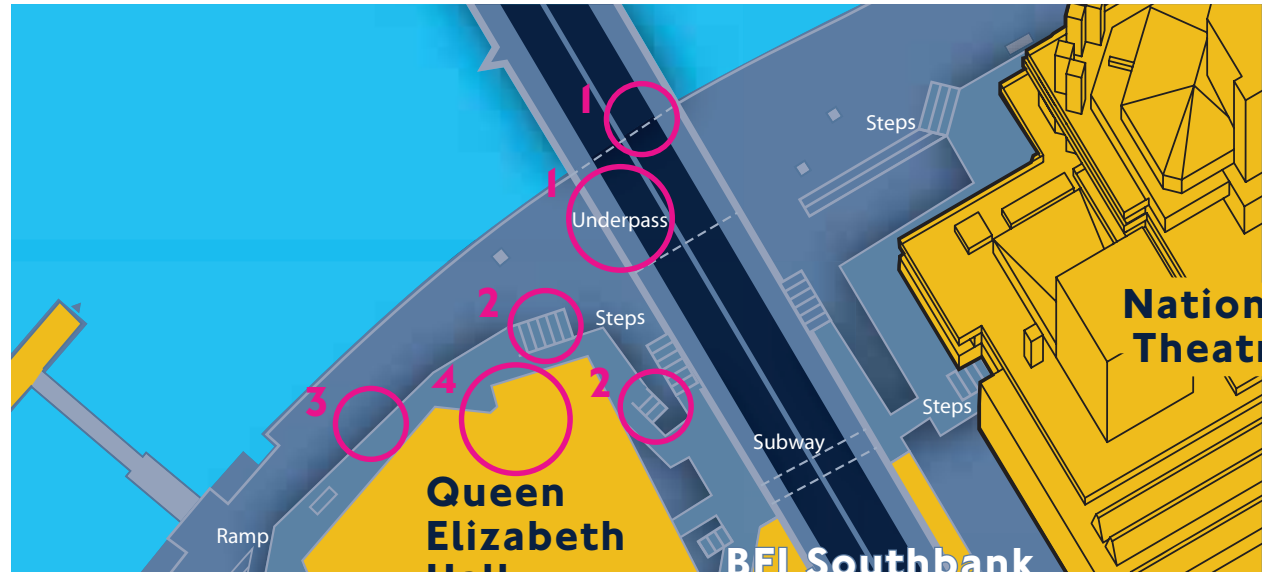

Upper level

C: 70
M: 44
Y: 22

Upper level drop shadow

Mode: Multiply
Opacity: 80%
X Offset: 0mm
Y Offset: 0mm
Blur: 2mm
Colour: C0-M0-Y0-K100

2.25.1 Multi-level areas (continued)

Contents



- 5 Landmark buildings that are under road/ pedestrian bridges should be shown only as sections adjacent to the structure in question. The pedestrian routes on the higher level bridge take precedence
- 6 Pedestrian features such as ramps should be emphasised to increase clarity
- 7 Enclosed steps that join upper/lower levels use the colour of the higher level as their fill
- 8 Steps that drop through a level are 'open' at the end where you enter the staircase from the top. As per standard steps, there should always be a minimum of three shown
- 9 Steps are properly drawn to perfectly fit the area they occupy preventing small sections of pavement being shown between the building and step edge as this would confuse users



2.26 Bridges, footbridges and viaducts

Bridges, footbridges and viaducts play an important part in illustrating the landscape of the city and aiding navigation. In the South Bank pilot area they are particularly prevalent and important to show clearly in relation to other pedestrian areas. When showing them on the map the following guidance should be followed:

- 1 The viaduct structure/rail base uses an additional colour, C54-M27-Y0-K60 at 50 per cent opacity with no outline. When it passes over a solid structure, for instance a building, or there is a section that you cannot pass under, a standard colour building polygon must be present. If it does not exist, an additional one must be drawn. Rail lines are 0.5pt, C87-M46-Y0-K81
- 2 Pedestrian routes under rail base are defined with dashed lines as per the specification of subways (0.75pt). The dashed line sits above rail lines and rail base and aligns with the edges of the building structure beneath it

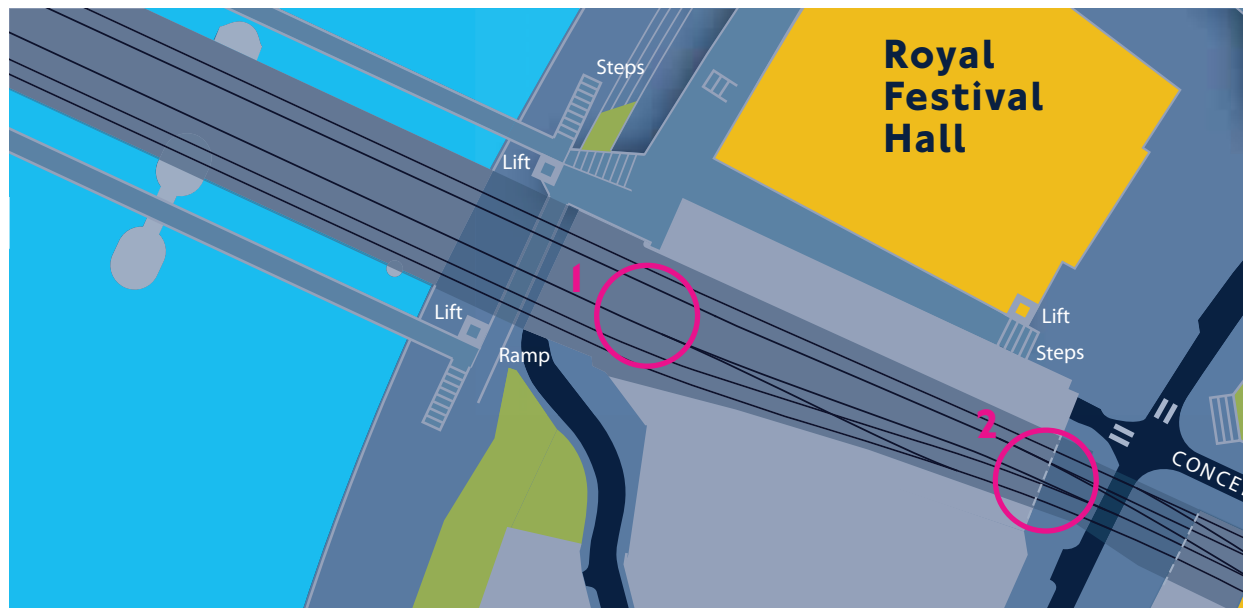

Viaduct structure/Rail base

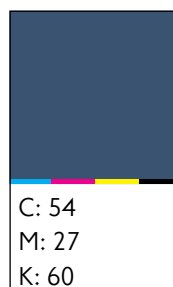

2.26.1 Bridges, foot bridges and viaducts (continued)

Contents



- 3 When a landmark building is under a viaduct the yellow building polygon should sit on top of the viaduct structure/rail base, with the rail lines running over the top of both
- 4 Steps accessing footbridges should be simplified wherever possible, as per the specification for regular steps
- 5 A drop shadow should be added to footbridges, signifying a raised walkway
- 6 Labels can be added to identity raised routes if required

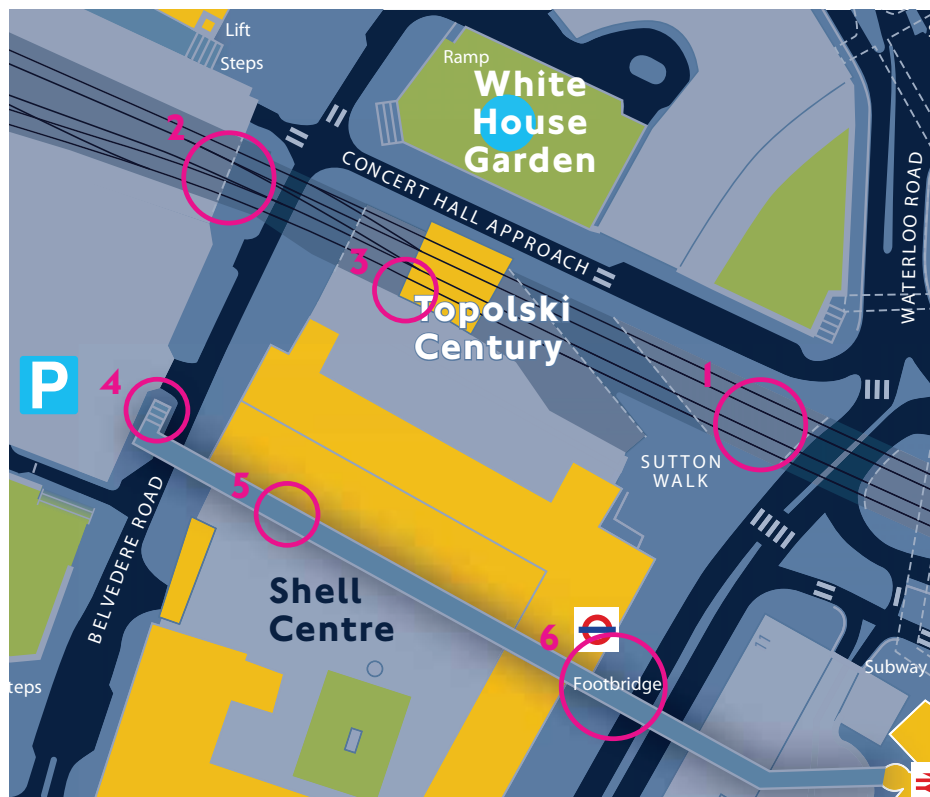

Footbridge drop shadow

Mode: Multiply
Opacity: 80%
X Offset: 0mm
Y Offset: 0mm
Blur: 2mm
Colour: C0-M0-Y0-K100

2.27 Railway lines and cuttings

Railway lines and cuttings are shown on the finder map as they are large urban features that need to be clearly identified and can be used for navigation purposes.

The area surrounding the railway lines (the rail base) is clearly delineated with a semi transparent colour, with the rail lines themselves running over the top.

There are different ways in which the railway lines intersect with other elements on the map – shown here is the style that should be used for those that are in cuttings or run predominantly at low level. Sometimes these are sunken into the ground and will perhaps be almost invisible behind walls or other barriers but are nonetheless important features. They will also, at different points along the line, pass either above or below roads.

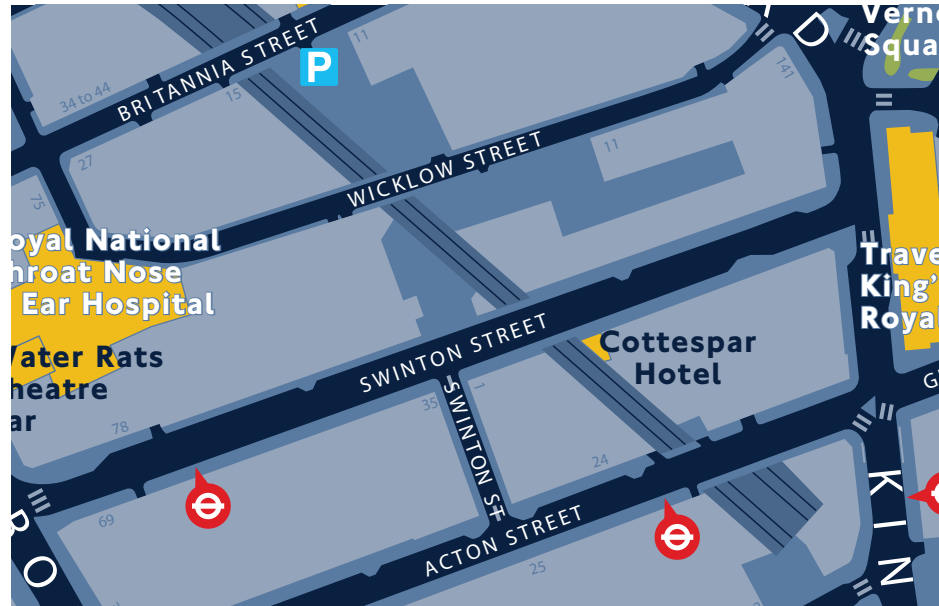

2.27.1 Railway lines and cuttings (continued)

Contents



- 1 When pedestrian routes pass under railway lines, they are defined with dashed lines as per the specification of subways (0.75pt). The dashed line sits above the rails and rail base and aligns with the edges of the route structure beneath it
- 2 When pedestrian routes pass over railway lines the roads and pavements appear uninterrupted, with the rail base and lines appearing only within the building areas - stopping at the edge of any pavements or roads, then continuing on the other side

When the railway lines are elevated for any great length, or run along a viaduct for example, a slightly different but related approach should be taken. Please see the previous section, Bridges, footbridges and viaducts, for details.



Rail base
Opacity: 50%
Colour: C54-M27-Y0-K60
Railway lines
Stroke weight: 0.5pt
Colour: C87-M46-Y0-K81

2.28 Rail over road names

Where railway lines go over a road, care should be taken to avoid a street label being shown under the bridge. Example one shows why it is difficult to read street names if placed incorrectly.

In example two, the street label has been split both side of the bridge, which is the best way to do it. Where it becomes impossible to do this then a shading needs to be placed under the label as shown in example three.

In some cases it may be necessary to place the label outside of the bridge and point it in but this should be avoided unless absolutely necessary.

In all cases, a hatched line should be used to indicate the width of the road underneath (road and pavement).

Where a railway line crosses a road at street level (level crossing) there should be no shading or hatched lines – see example four. Street labels should not be placed over the railway lines. A label 'Level crossing' should be added to clarify the road layout. Tram lines that run along a road should not be treated as level crossings, but will do only if they cross a road as in example four.



2.29 Internal space

There are instances where it may be relevant to illustrate the internal space/structures of a large landmark building/public space. In these instances the following guidance should be followed:

- 1 While the internal structures are shown in the standard landmark building yellow, the accessible areas have a transparent version of this colour. This element is made of two parts – there is a building colour polygon and on top of this is placed a duplicate yellow polygon with transparency set to 55 per cent. The solid yellow internal structures are placed on top of these
- 2 The divide between the routes through the building and the internal structures are outlined with a dashed line that has the same specification to that of the subways (0.75pt), but in white. This white dashed line sits on top of all other layers
- 3 Interior steps should be drawn to the same specification as regular steps but are shown in white



2.30 Campus buildings

Contents



Campuses have been identified as groups of assets that meet the asset selection criteria as a group, whilst not every one of the individual buildings within the campus would qualify as meeting the criteria. However, it is useful to let users know that they are in a university district in order for them to understand the character of the area.

The main building of a university campus should be marked as a landmark. The associated buildings should be labelled with an abbreviation or acronym of that particular institution, eg 'LSE' for London School of Economics.

Where a campus does not have an acronym the best abbreviation should be used. The type size of the label is sufficiently small to be used in most circumstances, though this will need to be considered on a case-by-case basis.



Campus building footprint

Stroke colour: C53-M27-Y0-K31
Stroke weight: 1pt

Main building label

Size: 12pt
Leading: 12pt
Typeface: NJFont Bold
Case: Sentence Case
Tracking: +50
Alignment: Left
Colour: C87-M46-Y0-K81

Associated building labels

Size: 8pt
Leading: 8pt
Typeface: NJFont Bold
Case: Sentence Case
Tracking: +50
Alignment: Left
Colour: C87-M46-Y0-K81

2.31 Airport/terminal

Contents



Airports/terminals should be depicted with the airport pictogram in the village name colour, centre aligned with the village itself, set to a height of 10mm on finder maps and 5.5mm on planner maps.



Airport/terminal and associated building - dark based specification

Airport/terminal

Building colour: C26-M13-Y0-K31
Base colour: C53-M27-Y0-K31
Stroke colour: C53-M27-Y0-K31
Stroke weight: 1pt
Dash line: 4pt, Gap: 2pt
Dash colour: C26-M13-Y0-K31

Main building label

Size: 12pt
Leading: 12pt
Typeface: NJFont Bold
Case: Sentence Case
Tracking: +50
Alignment: Left
Colour: C87-M46-Y0-K81

Associated building labels

Size: 8pt
Leading: 8pt
Typeface: NJFont Bold
Case: Sentence Case
Tracking: +50
Alignment: Left
Colour: C87-M46-Y0-K81

2.32 Prison buildings

Prison buildings are indicated if they are considered to be a landmark or useful for wayfinding. A stroke of 1pt must be used to highlight the footprint of the building and associated grounds.

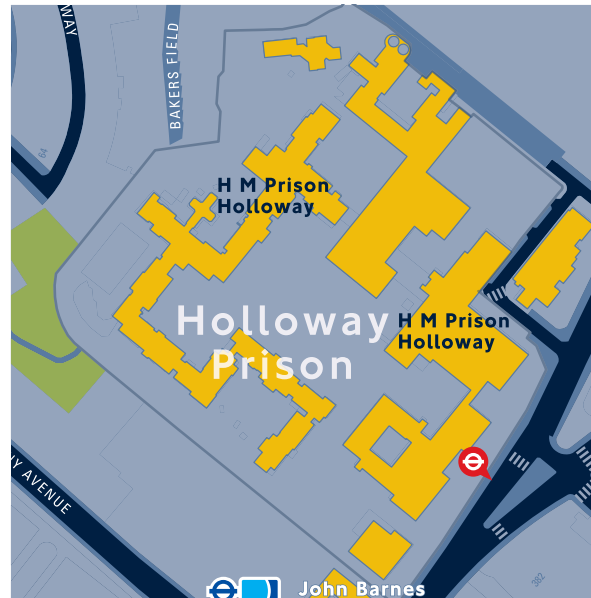

Contents



Prison buildings

Stroke colour: C53-M27-Y0-K31
Stroke weight: 1pt

Main building label

Size: 12pt
Leading: 12pt
Typeface: NJFont Bold
Case: Sentence Case
Tracking: +50
Alignment: Left
Colour: C87-M46-Y0-K81

Associated building labels

Size: 8pt
Leading: 8pt
Typeface: NJFont Bold
Case: Sentence Case
Tracking: +50
Alignment: Left
Colour: C87-M46-Y0-K81

2.33 Industrial areas

Industrial areas are indicated if they are considered to be a landmark or useful for wayfinding. A fill rather than just a stroke should be used to depict the shape of the area.

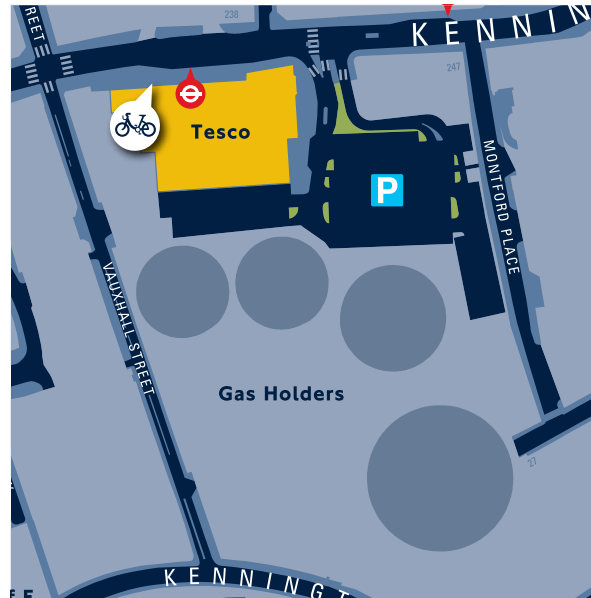

Contents



Industrial areas

Fill colour: C54-M27-
Y0-K60
Transparency: 50%

Building label

Size: 12pt
Leading: 12pt
Typeface: NJFont Bold
Case: Sentence Case
Tracking: +50
Alignment: Left or right
Colour: C87-M46-
Y0-K81

2.34 Hotel clusters

Contents



In some cases, clusters of assets do not meet the asset selection criteria for inclusion as individual buildings, but ought to be represented as a group of assets in order to accurately represent what an area is like.

As an example, there are a number of 'clusters' of hotels in the King's Cross area which do not meet the asset selection criteria on an individual basis, but if classified as a group can be considered as 'characteristic of the area.'

By removing the individual landmark labels for each of these smaller hotels and replacing it with a 'Hotels' label for a cluster of hotels, the legibility of the map is improved whilst representing the many hotels in the area.

This approach has been used in the Clear-zone pilot area for hotels but could be used elsewhere for other asset types. Any alternative asset clusters should be discussed with the system designers prior to finalising the map.

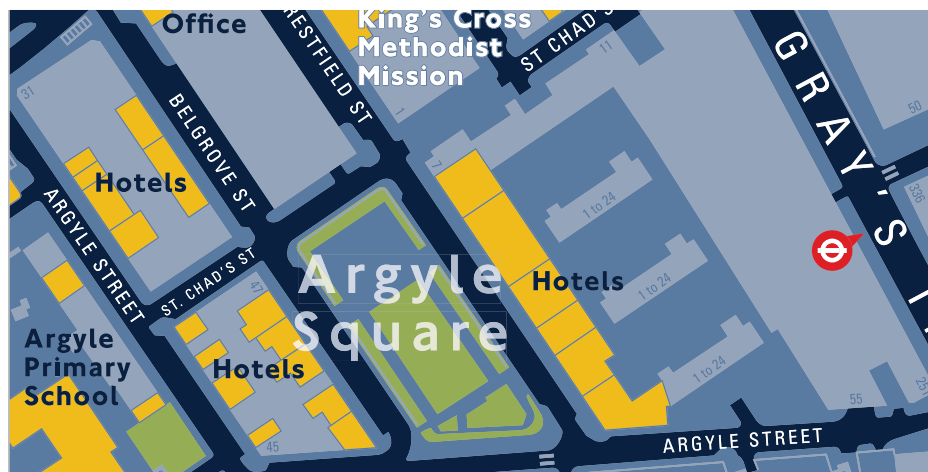

'Hotels' cluster label

Size: 12pt

Leading: 12pt

Typeface: NJFont Bold

Case: Sentence

Tracking: +50

Alignment: Left

Colour: C0-M0-Y0-K0

2.35 Definition of building footprint

Contents



Generally individual building footprints are not shown on TfL street maps, except in the case of landmark buildings.

In some instances however, it is useful to be able to show that a large area is actually made up of several different buildings and/or surrounding green/accessible space.

The example here shows one of these, in this instance a housing estate in South London, where it is useful to be able to identify that the area is made up of a series of buildings (which in this case have individual block numbers) and that there is actually a named square in the middle of the buildings.

This approach should not be used generally across the map, but is reserved for areas similar to that shown above – housing estates, blocks of flats etc – where the additional definition of the space helps the user understand important aspects of the urban form.

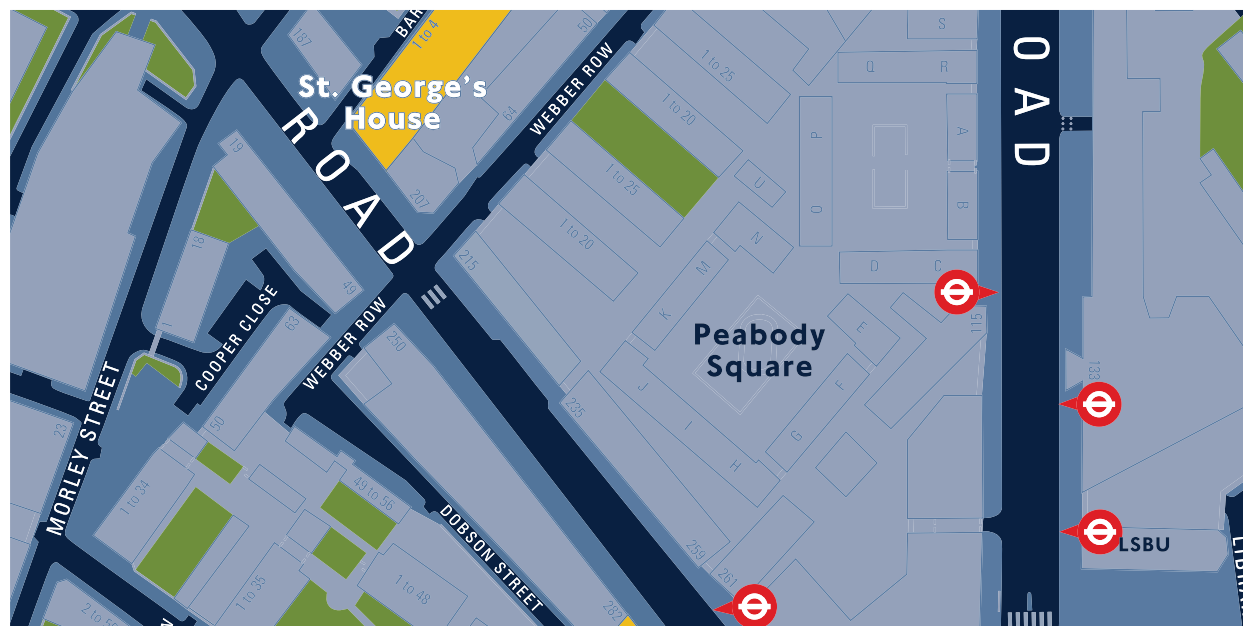

Building footprint

Stroke weight: 0.5pt
Colour: C53-M27-Y0-K31

2.36 Building numbers

Building numbers are included to give a sense of orientation and aid navigation along a specific route, when the user is looking for a particular address for example.

They should be edited down to an optimum number, avoiding visual clutter whilst helping users understand where they are on a street or which direction they need to head in.

As a rule, one number per building block is sufficient, though this will depend on the number and size of the blocks along a road and other connection roads. The example opposite illustrates an optimum density based on this approach.

As with road names, building numbers should read from top to bottom, unless this means the angle of the road would take the number clockwise, at which point they should be rotated through 180° to prevent them being inverted.



Building numbers

Size: 6pt
Typeface: Univers 57
Condensed
Colour: C53-M27-Y0-K31

2.37 'You are here' marker and walking circle

Contents



The 'You are here' and '5 minute walking circle' identify where the user is and the distance to featured destinations.

The 'You are here' marker is positioned with the horizontal bar above the arrow reflecting the location and orientation of the sign.

In terms of its position within the map crop, as a default the 'You are here' should be two thirds of the way down from the top of the map and horizontally centered, therefore giving a bias towards what is ahead of the user, rather than what is behind them.

The walking circle is placed centrally over the sign location.

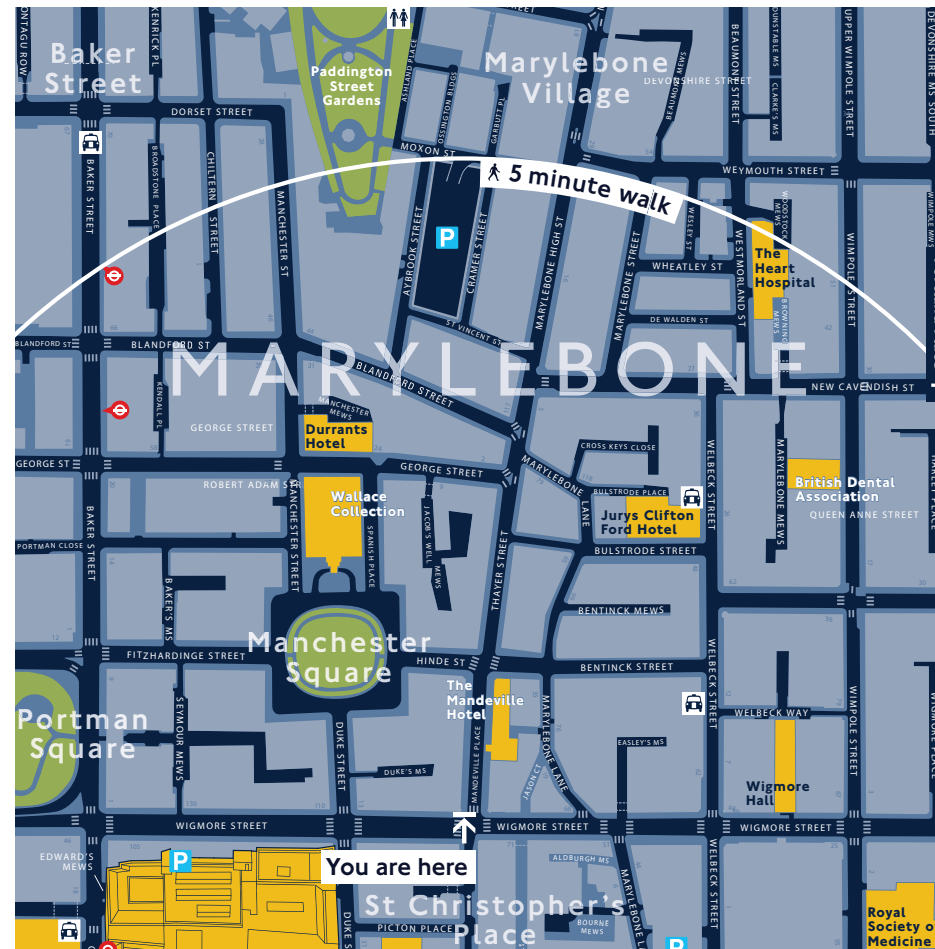

Walking circle
Stroke colour: C0-M0-Y0-K0
Stroke weight: 3.5pt

2.37.1 'You are here' marker and walking circle (continued)

The '5 minute walk' tab that is attached to the walking circle ranges left off the centre line of the circle, as the default preferred position, as shown here.

When this is not possible as a result of the map being congested with other elements, it should be ranged right off the centre line, as a second preferred option.

If neither of these two positions can be achieved it should be moved along the circle in either direction until an optimum position is achieved.

The 'You are here' marker also ranges off the centre line of the circle as shown here, and has four pre-defined versions to allow for optimised placement on congested areas of map. These are shown above, in order of preference.

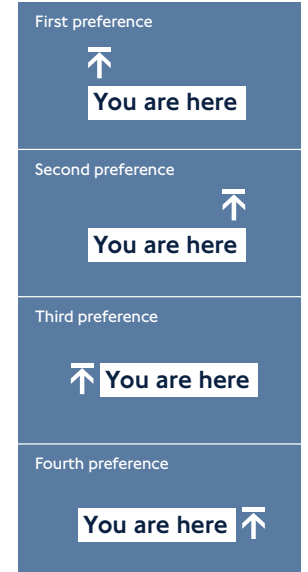
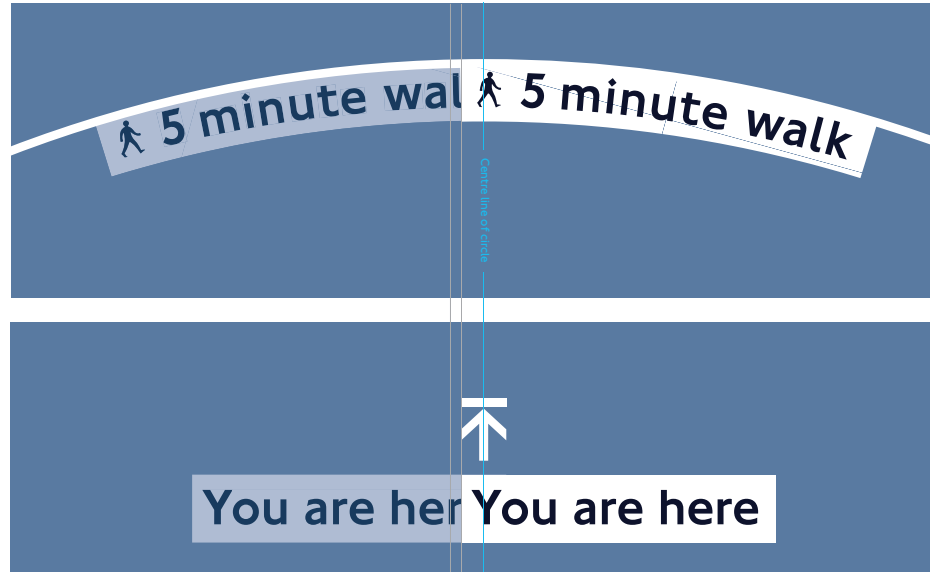

Optional 'You are here' marker layouts in order of preference.

2.37.2 'You are here' marker and walking circle (continued)

The '5 minute walk' tab and 'You are here' marker are constructed as shown. The cap height of text in both instances is 5mm.

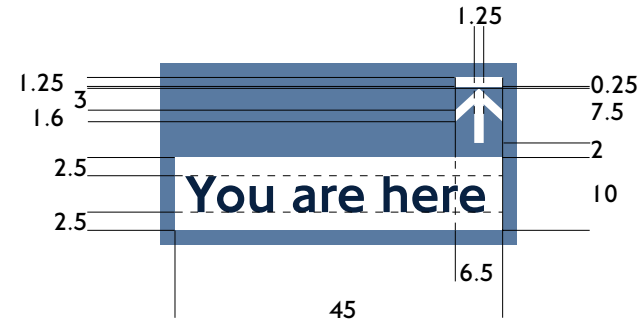

2.38 Infolith extended walking circle

Contents



Due to the width of some infoliths, the walking circle of the Finder map tends to be heavily cropped. This can make it difficult for the user to identify the circle clearly and place themselves at its centre.

To help clarify the full breadth of the walking circle and its centre point on the narrower format signs (infolith inner and outer), a subtle extension outside of the map is added.

The extended walking circle device is not used on infoliths where a full circle can be shown on a map.



Extended walking circle dots

Stroke colour: C0-M0-Y0-K0
Stroke weight: 3.5pt
Stroke type: Rounded cap
Dotted line:
0.25pt dash/9pt gap,
0.25pt dash/9pt gap

2.39 North indicator

A north indicator is included on the finder map to aid orientation and confirm the heads-up nature of the map.

It is placed in one of the four corners of the map – generally the corner with the least other map elements. Careful consideration should be given when placing the north indicator to avoid legibility issues between the north marker and any surrounding mapping elements.

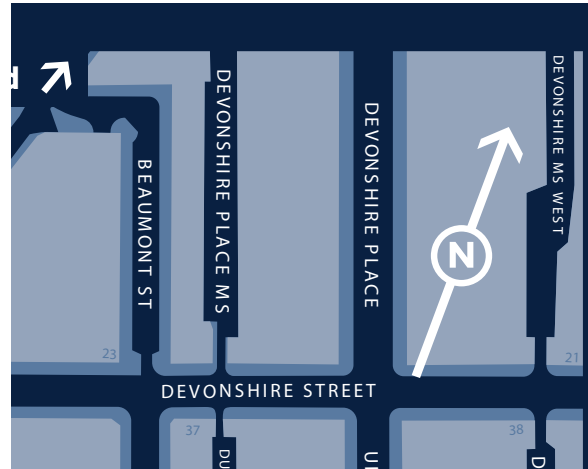

North indicator

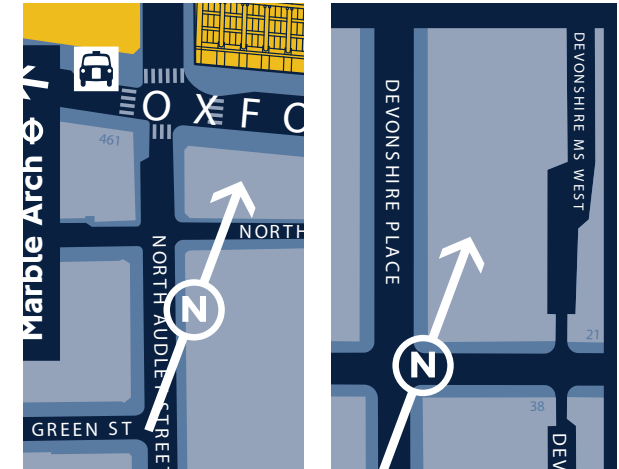

Bad placement of north indicator – putting the device over crowded areas or placing it too far from or too close to the corner is to be avoided

2.39.1 North indicator (continued)

The diagrams here show both how the north indicator should be positioned to sit comfortably in the corner, with visually equal margins around it, depending on its rotation, as well as how it is constructed.

Note that the 'N' within the marker is never rotated.

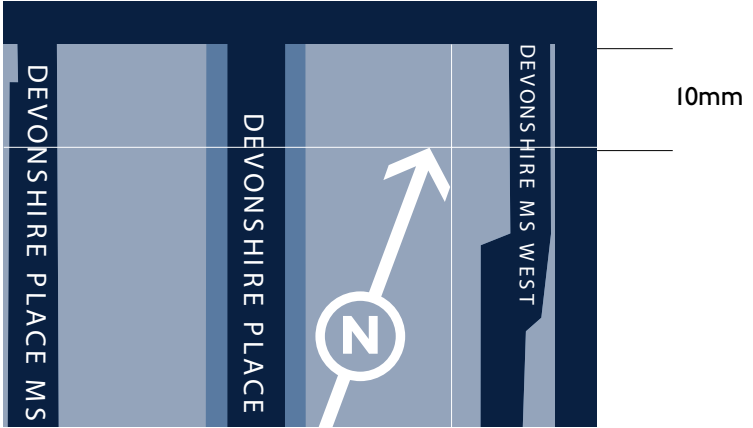
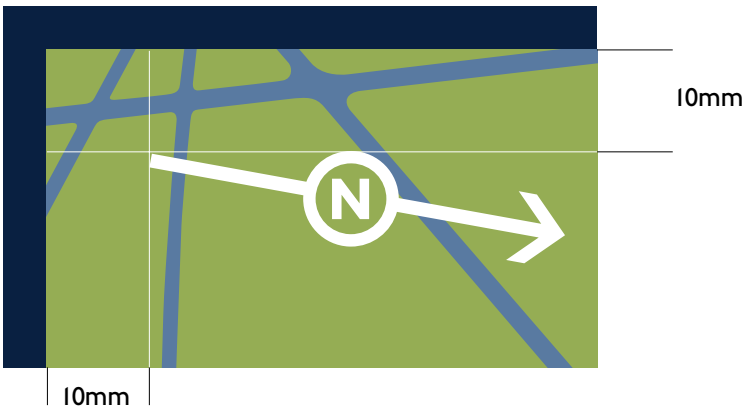

A 10mm optical margin should be included around the north indicator

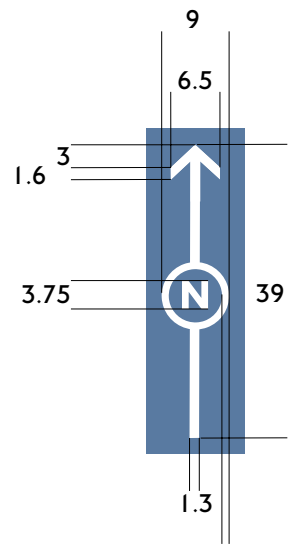

2.40 Off map tabs

Off-map tabs are included on the finder map to indicate important neighbourhoods or transport interchanges just beyond the map crop. They point out the best route to reach the destination from the sign location (usually based on the preferred route network).

Apart from on the bottom edge, the off-map tab should be positioned so the baseline of the text is facing into the map (labels on left and right-hand sides of the crop will run in opposing directions, shown above). The arrow should always be placed over (and pointing in the direction of) the road of the route which the pedestrian is advised to take, with the label placed to either the left or the right of the arrow (whichever is most appropriate, according to other nearby map elements).

A decision as to the amount of tabs included on each map crop needs to be made on a case by case basis. A balance needs to be made between providing useful information and overloading the map. As a guide, any more than two tabs per side of a infolith crop begins to appear crowded.

Network symbols should be shown as white pictograms in accordance with the TfL pictogram standard.



The off-map tabs can be applied in two different layouts dependent on available map space.

Arrows rotate around a central axis, in order to point in the direction of the recommended route for pedestrians.

2.41 Index – Grid

The index grid works in conjunction with the street finder and landmark finder indexes that sit below the map.

The width and height of the finder maps should be divided up to create grid 'squares' of approximately 85mm - 90mm. Due to the sizes of the maps used on each sign these will not be exact, but will be sufficiently close to appear consistent across the product range.

The amount of grid divisions on the horizontal axis also defines the number of columns used in the street/landmark finder.

Vertical axes should be numbered, starting top left of the map, while horizontal axes use letters and start bottom left.

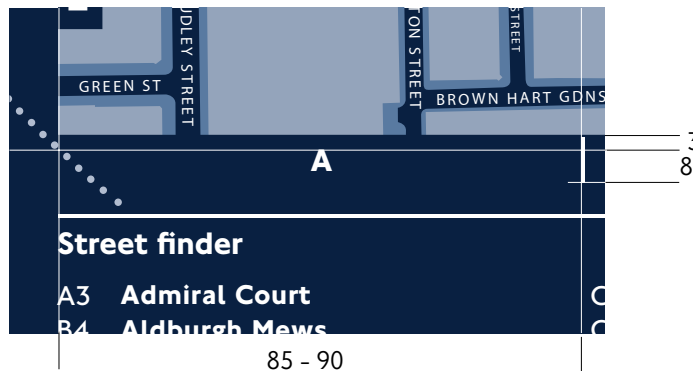

Grid references
Size: 16pt
Typeface: NJFont Bold
Alignment: Centered
Colour: C0-M0-Y0-K0
Dividing lines
Height: 8mm
Stroke: 1.5pt
Colour: C0-M0-Y0-K0

2.42 Index – Street finder

All roads featured within the crop of the finder map should be included on the Street finder index.

When a road spans across several grid squares, the reference for the most relevant or obvious labelled section of the road to the user should be used.

The street finder is organised in alphabetical order and when dividing the columns it is recommended that they are done so by keeping groups of names with the same initial letter together as this can help users when searching the index for particular entries. If this is not workable in terms of the layout, names should be grouped based on the second letter.

Columns should be split to give an even feel to the overall layout of the indexes and key, though the columns need not be all the same length, as shown above.

Please see the following pages for specific information on the landmark finder and key.

A		B		14
Street finder				6.5
A3	Admiral Court	C3	Harley Place	9
B4	Aldburgh Mews	C5	Henrietta Place	

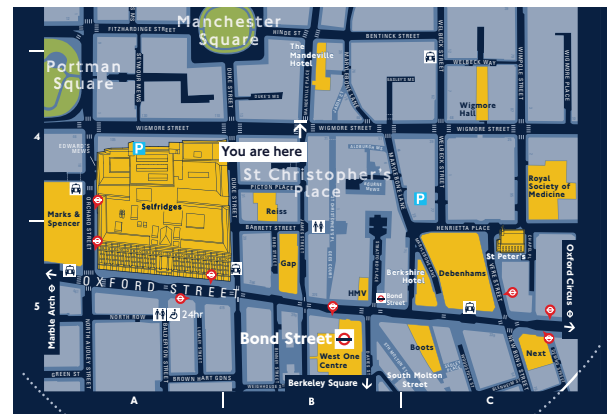

Street finder			
A3	Admiral Court	B5	Weighhouse Street
B4	Aldburgh Mews	C3	Welbeck Street
B1	Ashland Place	C4	Welbeck Way
B2	Aybrook Street	C2	Wesley Street
A3	Baker Street	C2	Westmorland Street
A3	Baker's Mews	C2	Weymouth Street
A5	Balderton Street	C2	Wheatley Street
B5	Barrett Street	C4	Wigmore Place
B1	Beasmont Mews	A4	Wigmore Street
C1	Beasmont Street	C2	Wimpole Mews
B3	Bentnick Mews	C2	Wimpole Street
B3	Bentnick Street	C2	Woodstock Mews
B1	Bingham Place	C5	Woodstock Street
B5	Binney Street	A1	York Street
B3	Bird Street		
B5	Blandford Street		
C5	Blenheim Street		
B4	Bourne Mews		
A2	Broadstone Place		
A5	Brown Hart Gardens		
C2	Browning Mews		
B3	Bulstrode Place		
B3	Bulstrode Street		
C5	Chapel Place		
A2	Chiltern Street		
C2	Clark's Mews		
B2	Cramer Street		
A1	Crawford Street		
B2	Cross Keys Close		
B4	Dawley Street		
C3	Harley Place		
C5	Henrietta Place		
B3	Hinde Street		
B3	Jacob's Well Mews		
B5	James Street		
B4	Jaxon Court		
A2	Kendall Place		
A1	Kenrick Place		
A5	Lumley Street		
B1	Luxborough Street		
B3	Manchester Mews		
B3	Manchester Square		
A2	Manchester Street		
B4	Mandeville Place		
B2	Marylebone High Street		
B4	Marylebone Lane		
C3	Marylebone Mews		
C3	Marylebone Street		
A1	Montagu Row		
B2	Moxon Street		
C5	New Bond Street		
C2	New Cavendish Street		
A5	North Audley Street		
A5	North Row		
B1	Nottingham Mews		
B1	Nottingham Street		
B1	Oldbury Place		
A5	Orchard Street		
B2	Osington Buildings		
A5	Oxford Street		

Landmark finder	
C3	British Dental Association
B3	Durrants Hotel
C2	The Heart Hospital
B1	The Hellenic Centre
B1	High Commission of The Republic of Maldives
C3	Jurys Clifton Hotel
B4	The Mandville Hotel
A1	Park Plaza Sherlock Holmes Hotel
C4	Royal Society of Medicine
A4	Selfridges

Street finder text

Size: 16pt (heading) & 14pt (list)
 Leading: 17pt
 Typeface: NJFont Bold (street names) & Light (coordinates)
 Case: Upper & lower
 Alignment: Left
 Colour: C0-M0-Y0-K0

Rule

Stroke weight: 1.5pt
 Colour: C0-M0-Y0-K0

2.43 Landmark finder

The Landmark finder acts to provide information about the location of the most commonly searched for landmarks. It is made up of an edited list of landmarks that appear on the sign's finder map crop.

Due to space considerations and the possibility of overloading users with too long an index, only an edited list of landmarks is included.

Post offices and police stations are not listed on the Landmark finder.

Where the landmark name runs over two lines within the Landmark finder the second line should be indented, this indent should be determined by the X-width of the initial capital letter.

Contents

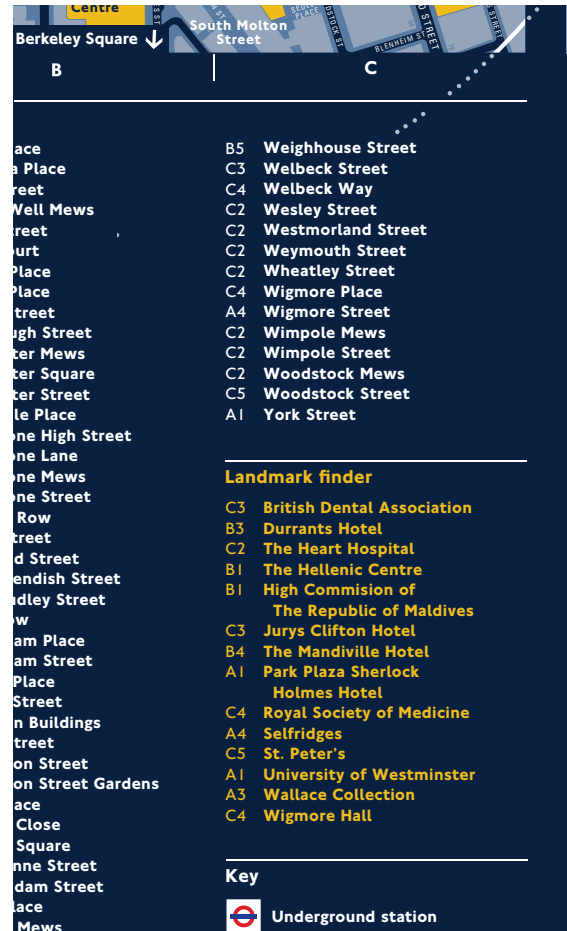

Landmark finder typography

Size: 16pt (heading) & 14pt (list)

Leading: 17pt

Typeface: NJFont Bold (landmark names)

& Light (coordinates)

Case: Upper & lower

Alignment: Left

Colour: C0-M22-Y100-K6

Dividing rule

Stroke weight: 1.5pt

Colour: C0-M0-Y0-K0

2.43.1 Landmark finder (continued)



Abbreviations may be used on the map where full names cannot be accommodated but these should be avoided within the index.

Full stops should only be used where St. is representing saint (abbreviations Rd for road and St for street should not have full-stops.)

For landmark names the word “The” should only be used in exceptional circumstances where the names would appear awkward without.

Eg: British Museum
London Eye
The Oval

Whilst statues and fountains may be named on the map, only major memorials such as the Cenotaph should appear in the index.

Well established landmarks should be listed by their commonly known names, where the display of the full or “correct” name is not in customers interests and may conflict with other popular maps.

Eg: Big Ben
Regent’s Park
London Zoo

Street names should be in alphabetical order using exactly the name shown on the map eg. Borough High Street under B (not under H for High Street, Borough).

Embassies can be given their own heading within the landmark finder to ensure all ‘embassy-type’ landmarks are captured, ie High Commissions, Embassies, Consulates.

Where elements in the index have to go over two lines, the second line should be indented to preserve the clear alphabetical appearance.

Where a complex of buildings has a single overall name such as a University the individual building names may be shown in the index but positioned directly below the primary name, the primary name only displaying the grid reference:

B2: Magistrates’ Court
Coroners Court - see Magistrates’ Court
Youth Court - see Magistrates’ Court

2.44 Index – Key



A key has been included within the index to help clarify the meaning of certain pictograms used on the maps.

Currently only transport interchange pictograms are included as testing has shown that these are sometimes misinterpreted by new users. This could be added to in future, for example to help clarify new map elements such as a new mode of public transport that will not be intuitively understood.

All pictograms should be reproduced at the same scale to those that appear on the finder map. Where subsidiary pictograms are used on the finder map these are not required on the key.

Where shopping or food and drink pictograms are shown on the finder map, one or both sets should be shown, each with the two generic symbols.

Key

- A4 **Selfridges**
- C5 **St. Peter's**
- A1 **University of Westminster**
- A3 **Wallace Collection**
- C4 **Wigmore Hall**

Key

-  **London Underground station**
-  **London Overground station**
-  **DLR Docklands Light Railway station**
-  **London Buses Bus station**
-  **River pier**
-  **National Rail station**
-   **Shopping**
-   **Food and drink**

Key

Size: 16pt (heading) & 14pt (list)
Leading: 34pt
Typeface: NJFont Bold
Case: Upper & lower
Alignment: Left
Colour: C0-M0-Y0-K0

Dividing rule

Stroke weight: 1.5pt
Colour: C0-M0-Y0-K0

Transport modes shown within the key in the order that they are to be listed

2.45 Copyright text for infolith maps

Copyright text is always to be displayed beneath the street finder.

The text is placed in the bottom left-hand corner of the mapping and index panel, on both sides of the sign.

Text is left-aligned and fits within the width of one column of the sign's index. This width will vary with each different sign type due to the change in index width.

Only where there are space constraints, it is permissible for this text to go over into two columns.

The baseline of the last line of text sits on the edge of the panel's graphic area.

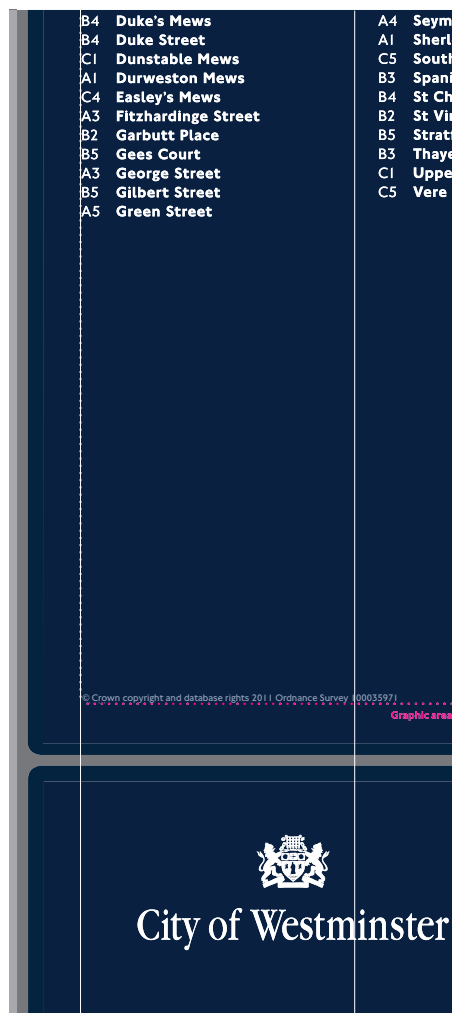

Copyright text
Size: 8pt
Leading: 9pt
Typeface: NJFont Light
Case: Upper & lower
Alignment: Left
Colour: C26-M13-Y0-K24

© Crown copyright and database rights 2011 Ordnance Survey 100035971

The detailed wording for the copyright information is as shown above

Copyright text spans width of single column of the signs index

2.46 Branding

With a infolith finder map, branding should only ever be displayed on actual infrastructure (such as a street infolith or Cycle Hire terminal). It is never to be displayed on any part of the infolith finder map (including the index area and surrounding dark background)

Only a borough logo and TfL mark are permitted on the face of a street infolith, in the order and arrangement shown in the example here. The width of the TfL mark is 100mm. The borough logo is to be scaled to give visual balance. Both logos are vertically centred and aligned to the side margins

Logos must always be shown in white. No colour logos are permitted.

Single colour, vector based logos for the respective boroughs should be sourced independently.

The size and position of the borough logo must be approved by TfL Design.

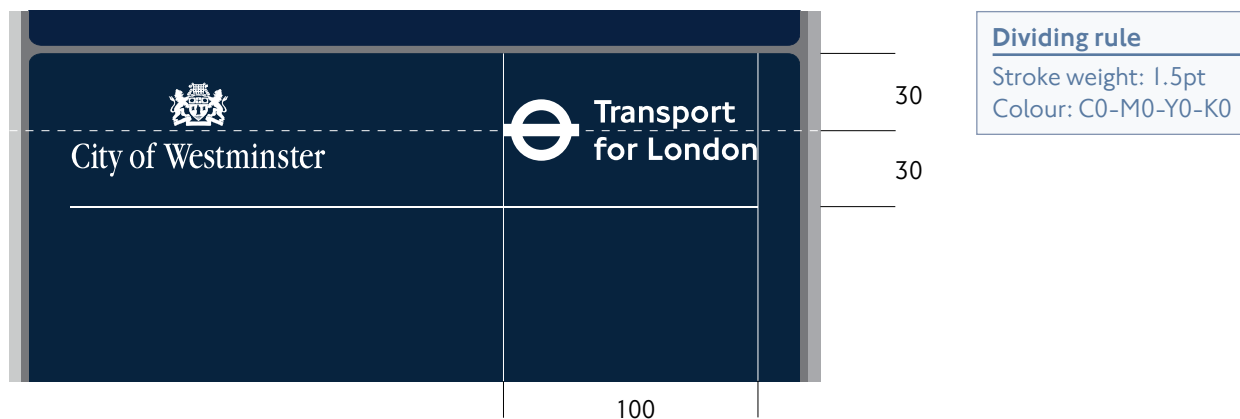

3 Mapping elements for the printed finder map



As with the infolith finder map, the printed finder map is used to find a destination.

This section of the document gives guidance on converting the infolith finder map into the printed finder map used in leaflets and posters.

The colour conversions are not merely a straight swap of light colours for dark colours, so the detailed matrix of colour changes should be closely followed whenever creating a light based map artwork.

Note that the printed finder map is always to be displayed in a north-up orientation.



3.1 Colours (printed map)

The printed finder map has its own unique colour palette.

For a full breakdown of uses and other specific details, please refer to the quick reference matrix on the following pages.

Road base



C: 0
M: 0
Y: 0
K: 0

Pedestrian area



C: 18
M: 9
Y: 2

Buildings

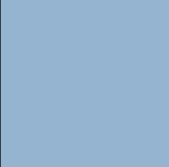

C: 36
M: 15
Y: 3
K: 7

Landmark buildings



M: 18
Y: 100

Water/parking

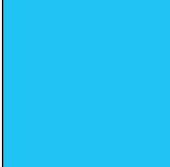

C: 65

Green areas



C: 45
M: 5
Y: 60

Woodland areas



C: 55
C: 7
M: 70
Y: 15

Bus stops



M: 100
Y: 100

Landmark labels



C: 100
M: 45
K: 70

Road/area names



C: 70
M: 25
K: 50

Multi level areas

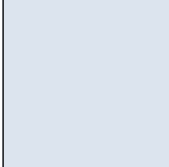

C: 12
M: 6
Y: 2

Steps and barrier linework



C: 36
M: 15
Y: 3
K: 7

Viaduct/Rail base (50% opacity)

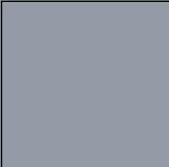

C: 18
M: 9
Y: 2
K: 50

3.2 Matrix of changes for conversion

[Contents](#)



The following table sets out all the changes that are required to be made to convert a infolith finder map into a printed finder map and the order in which they should be done.

As described earlier, the conversion is not merely a straight swap of light colours for dark. However, the table shown does set out a process of making some 'global' changes from dark to light initially, that are then adjusted or detailed accordingly.

Please note, only elements that require alteration are included here.

3.2.1 Matrix of changes for conversion (continued)



Element	Type of change	Dark base specification	Light base specification
Stage 1: Colour changes			
Road base	Global colour change	Colour: C87-M46-Y0-K81	Colour: C0-M0-Y0-K0
Pedestrian area	Global colour change	Colour: C53-M27-Y0-K31	Colour: C18-M9-Y2-K0
Buildings	Global colour change	Colour: C26-M13-Y0-K24	Colour: C36-M15-Y3-K7
Landmark buildings	Global colour change	Colour: C0-M22-Y100-K6	Colour: C0-M18-Y100-K0
Water/parking	Global colour change	Colour: C75-M0-Y0-K0	Colour: C65-M0-Y0-K0
Green areas	Global colour change	Colour: C40-M10-Y80-K10	Colour: C45-M5-Y60-K0
Woodland areas	Global change colour	Colour: C55-M7-Y70-K15	Colour: C55-M7-Y70-K15
Open areas	Global change colour	Colour: C28-M3-Y37-K0	Colour: C28-M3-Y37-K0
Bus stops	Global colour change	Colour: C0-M100-Y100-K6	Colour: C0-M100-Y100-K0
Multi level areas	Global colour change	Colour: C70-M44-Y22-K0	Colour: C12-M6-Y2-K0
Steps and barrier line-work	Global colour change	Colour: C26-M13-Y0-K24	Colour: C36-M15-Y3-K7
Viaduct/rail base	Global colour change	Colour: C54-M27-Y0-K60	Colour: C18-M9-Y2-K50
Rail lines	Isolated colour change	Colour: C87-M46-Y0-K81	Colour: C100-M25-Y0-K50
Multi level drop shadow	Opacity change	80% opacity	40% opacity
Cycle Hire drop shadow	Opacity change	80% opacity	40% opacity
3D building line work	Isolated colour change	Colour: C87-M46-Y0-K81	Colour: C100-M25-Y0-K50
Stage 2: Text element style changes			
Villages	Change opacity and colour	Opacity: 80% Colour: C0-M0-Y0-K0	Opacity: 40% Colour: C100-M45-Y0-K70
Neighbourhoods	Change type size, leading, opacity and colour	Size: 25pt Leading: 25pt Opacity: 85% Colour: C0-M0-Y0-K0	Size: 21pt Leading: 21pt Opacity: 55% Colour: C100-M45-Y0-K70
Road names	Change colour	Colour: C0-M0-Y0-K0	Colour: C70-M25-Y0-K50

3.2.2 Matrix of changes for conversion (continued)



Element	Type of change	Dark base specification	Light base specification
Stage 2: Text element style changes			
Landmark labels	Change typeface, tracking and colour	Typeface: NJFont Bold Tracking: +50 Colour: C87-M46-Y0-K8I or C0-M0-Y0-K0	Typeface: NJFont Medium Tracking: +35 Colour: C100-M45-Y0-K70
Monuments and gates	Change colour	Colour: C0-M0-Y0-K0	Colour: C70-M25-Y0-K50
Areas of water (not including River Thames)	Change typeface, tracking and colour	Typeface: NJFont Bold Tracking: +50 Colour: C0-M0-Y0-K0	Typeface: NJFont Medium Tracking: +35 Colour: C100-M45-Y0-K70
Squares and gardens	Change typeface and colour	Typeface: NJFont Bold Colour: C0-M0-Y0-K0	Typeface: NJFont Medium Colour: C100-M45-Y0-K70
Private gardens	Change colour	Colour: C0-M0-Y0-K0	Colour: C100-M45-Y0-K70
Underground, bus and rail stations	Change colour	Colour: C0-M0-Y0-K0	Colour: C100-M45-Y0-K70
Steps/Ramps/Lifts label	Change typesize, leading, typeface and colour	Size: 6pt Leading: 6pt Typeface: Univers 67 Bold Condensed Colour: C0-M0-Y0-K0	Size: 8pt Leading: 8pt Typeface: Univers 57 Condensed Colour: C70-M25-Y0-K50
Active frontage text	Change colour and opacity	Colour: C0-M0-Y0-K0	Box colour: C100-M45-Y0-K70 Opacity: 40%
Associated building labels	Change colour	Colour: C87-M46-Y0-K8I	Colour: C70-M25-Y0-K50
Stage 3 Pictogram changes			
Underground stations, bus stations, rail stations and piers	Add outline stroke	Box outline: 0pt	Box outline: 0.5pt Outline colour: C70-M25-Y0-K50
Toilet facilities	Change colour and add outline stroke	Pictogram blue: C87-M46-Y0-K8I Box outline: 0pt	Pictogram blue: C70-M25-Y0-K50 Box outline: 0.5pt Colour: C70-M25-Y0-K50
Taxis	Change colour and add outline stroke	Pictogram blue: C87-M46-Y0-K8I Box outline: 0pt	Pictogram blue: C70-M25-Y0-K50 Box outline: 0.5pt

3.2.3 Matrix of changes for conversion (continued)



Element	Type of change	Dark base specification	Light base specification
Stage 2: Text element style changes (continued)			
A&E pictogram	Add outline stroke	Box outline: 0pt	Box outline: 0.5pt Outline colour: C70-M25-Y0-K50
Active frontage pictograms	Change colour and opacity	Pictogram blue: C87-M46-Y0-K81 Box outline: 0pt	Box colour: C100-M45-Y0-K70 Opacity: 40%
Building entrance pictograms	Change colour	Arrow and circle outline blue: C87-M46-Y0-K81	Arrow and circle outline blue: C70-M25-Y0-K50
Bus stops	Replace roundel with bus stop code	TfL roundel	Bus stop code Size: 9pt Typeface: NJFont Bold Case: Upper Alignment: Centred Colour: C0-M0-Y0-K0
Stage 4: Top level element changes			
You are here marker	Change opacity and colour of box (but not text)*	Box opacity: 100% Box colour: C0-M0-Y0-K0	Box opacity: 30% Box colour: C100-M45-Y0-K70
Walking circle	Change opacity and colour of circle and tab (but not text)	Circle and tab opacity: 100% Circle and tab colour: C0-M0-Y0-K0	Circle and tab opacity: 30% Circle and tab colour: C100-M45-Y0-K70
North indicator	Change opacity and colour	Opacity: 100% Colour: C0-M0-Y0-K0	Opacity: 40% Colour: C70-M25-Y0-K50
Off-map tabs	Change opacity and colour of box (but not text)	Bounding box opacity: 100% Bounding box colour: C87-M46-Y0-K81	Bounding box opacity: 40% Bounding box colour: C100-M45-Y0-K70
Grid rules	Introduce new element	n/a	Stroke: 0.5pt Colour: C100-M45-Y0-K70

3.2.4 Matrix of changes for conversion (continued)



Element	Type of change	Dark base specification	Light base specification
Stage 4: Top level element changes (continued)			
Grid reference side panelling	Introduce new element	n/a	Opacity: 40% Colour: C100-M45-Y0-K70
Grid references	Introduce new element	n/a	Size: 12pt Typeface: NJFont Bold Alignment: Left Colour: C0-M0-Y0-K0
Ticket stops	Introduce TfL ticket stop logos	n/a	As per pictogram specification
Underground station entrances	Introduce numbered Underground entrances	n/a	As per pictogram specification
Coach stops	0.75pt stroke applied	Colour: C87-M46-Y0-K81	Colour: C70-M25-Y0-K50

*The You are here marker varies in style between different applications. It will sometimes feature as the standard arrow device or can be used in conjunction with another map pictogram (Underground pictogram, Car park pictogram, etc) to show its position. When an arrow is used it should be the same colour and opacity of the box.

3.3 Selected examples of printed finder map



The rules within this section of the document are those to be used for the infolith finder map only.

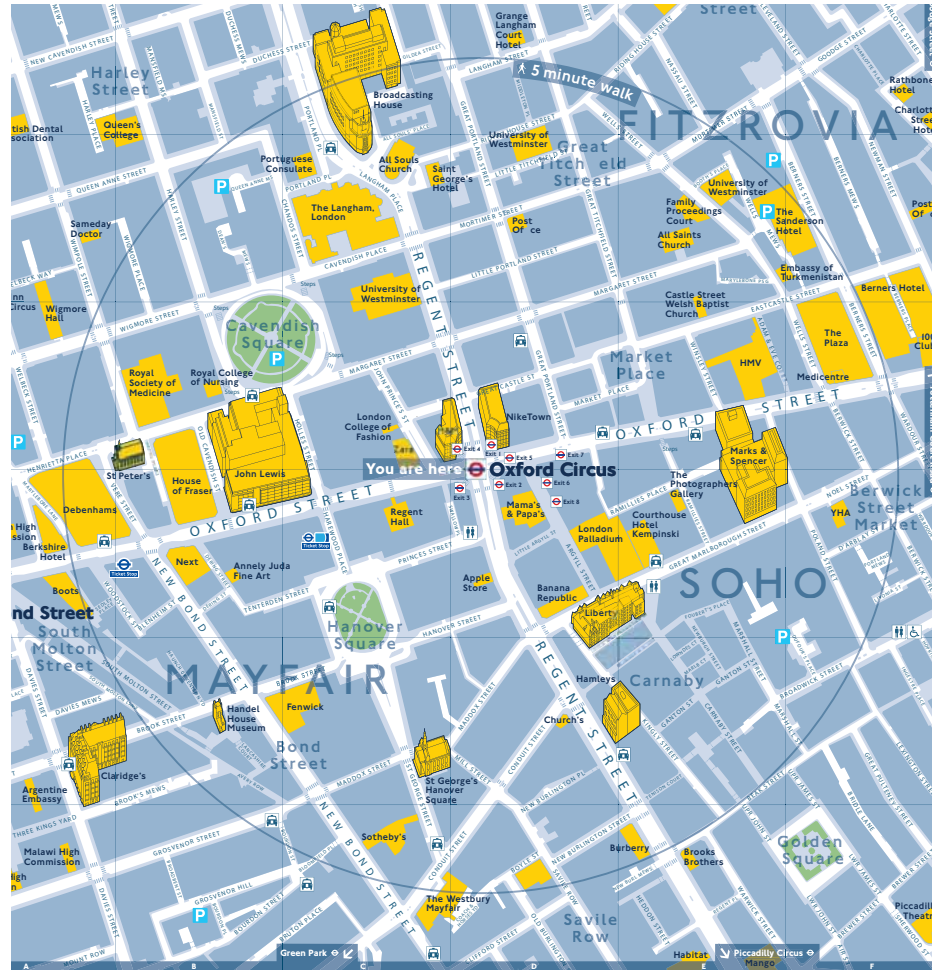

Finalised map artwork for QR poster at Oxford Circus underground station

3.3.1 Selected examples of printed finder map (continued)

Contents

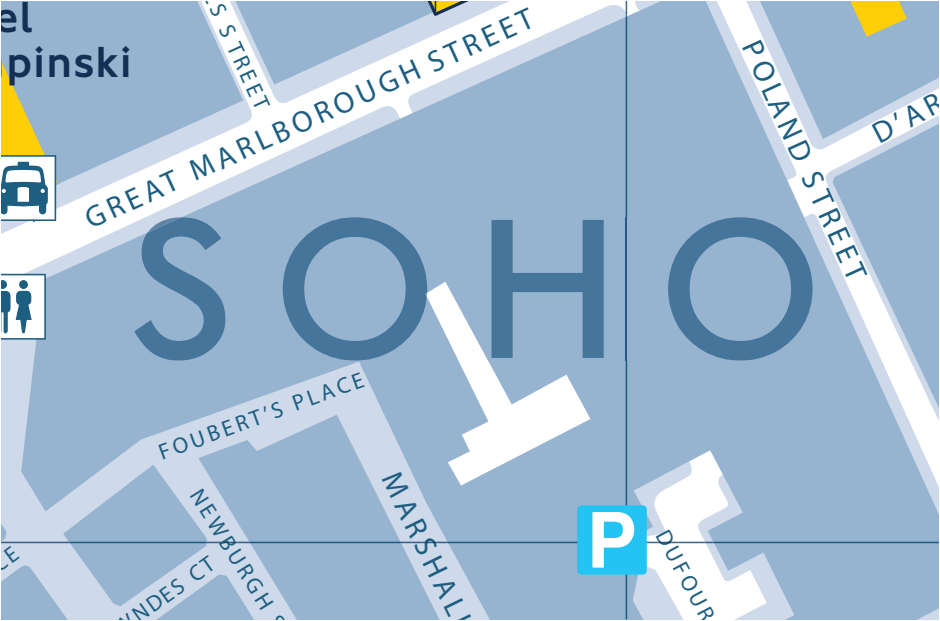

Villages



Major road names (18pt)

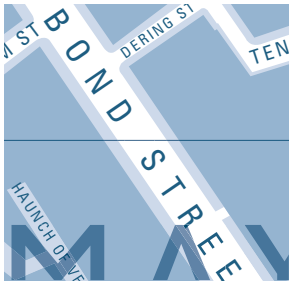

Major road names (13pt)



Minor road names (6pt and 8pt)

3.3.2 Selected examples of printed finder map (continued)



Neighbourhoods



Landmark building labels



Underground and rail stations



Underground and rail entrances

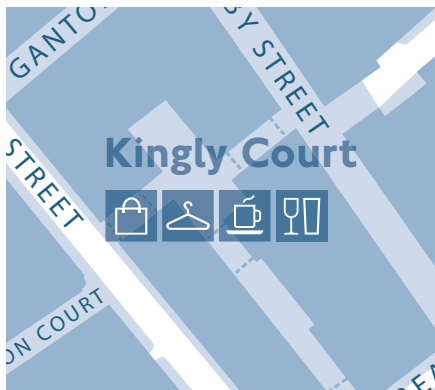

Active frontage

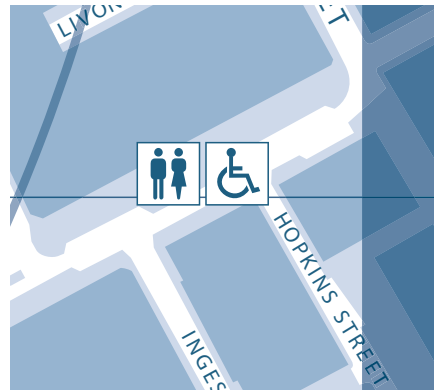

Toilet pictograms



Taxi pictograms



Parking pictograms

3.3.3 Selected examples of printed finder map (continued)

The 'You are here' marker varies in style between different applications. It will sometimes feature as the standard arrow device or can be used in conjunction with another map pictogram (Underground pictogram, Car park pictogram, etc) to show its position. When an arrow is used it should be the same colour and opacity of the box

The grid rule and the incorporated tabs on the reference panel should only be placed on the bottom and right hand side of the finder map.



You are here marker*

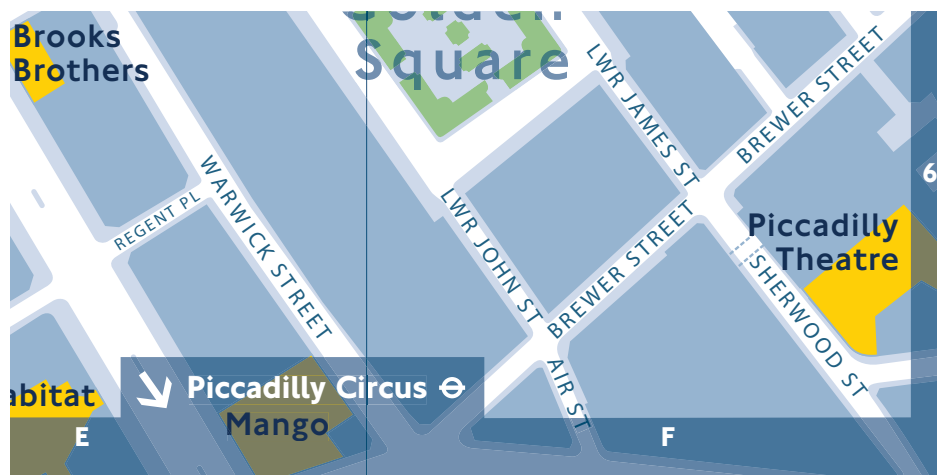

Grid rules and reference panel, plus the option of off map tabs incorporated into the grid reference panel, these should be placed on only the bottom and right hand side of the map.

3.3.4 Selected examples of printed finder map (continued)



Walking circle



Internal spaces



Off map tabs

3.3.5 Selected examples of printed finder map (continued)

Generally, to indicate the presence of two distinct levels, a dark grey key-line should be used as a border to the upper level. A drop shadow must be used below for walkways were appropriate.

For tunnels and bridge abutments, a key-line should be used along the overhanging edge of the pavement. Where elements pass over walking paths, the walking routes must take visual priority.



Multi levels and viaduct structure/rail base

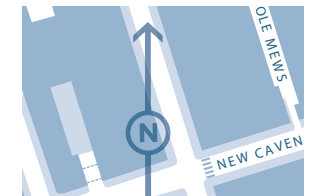

North marker

3.4 Copyright text for printed maps

[Contents](#)



When producing a printed finder map the following copyright text should always accompany the map: © Crown copyright and database rights 2011 Ordnance Survey 100035971

Note that the above text differs from the copyright text that is applied to infolith maps.



The planner map is used to orientate the user and show how close the villages are to each other. It provides the user with the information needed to link areas of London and the confidence to attempt longer distance walking journeys.

Guidance to application of standards

- The use of secondary road names on primary roads should be considered to ensure elements do not get too close and cause visual noise
- Avoid abbreviations where possible
- Avoid overlapping elements wherever possible (village names are transparent so can overlap other elements, but in doing so, the layout becomes busy - this should be avoided where possible)
- Ensure road names are aligned correctly within the road and also follow the shape of the road
- Road names should be aligned centrally within the line width (road names not

centrally aligned or running at different angles to the road create visual noise and looks untidy)

- Separate duplicate elements where possible. (where village names are placed very close to Tube station names the map tends to look cluttered - villages are by default larger areas and the placement of the labels can be more flexible to fit around other elements that have to be more precisely placed
- The smaller village names option (18pt) should be employed more readily in heavily congested areas (this will give other items breathing space, but it is important that visual balance is retained so that areas are not seen to be given a false hierarchy)
- When there is an even mix of 25pt and 18pt village labels then it is fine to use both, as per the current guidelines. However, if 60 per cent or more of the labels have to be reduced to 18pt due to map congestion then all labels should be

reduced (this will make sure that no false hierarchies are created when perhaps only one or two labels are shown at the larger size)

4.1 Finder map window

Contents



A highlighted 'window' is used on the planner map to identify the area that is represented on the corresponding finder map, allowing users to switch between the maps more easily and relate common elements.



Finder map window

Colour: C51-M36-Y18-K6

Opacity: 80% (set on multiply)

Element positioned above base, water and green spaces layers but beneath all others

4.2 Villages

Contents



Villages on a planner map are shown in uppercase translucent type. As a default 25pt should be used, but a secondary size (18pt) is available to aid legibility on heavily congested sections of the map and enable the inclusion of names at the edges of the map crop.

No other type size should be used to represent village names – if a name will not fit comfortably it should be omitted.

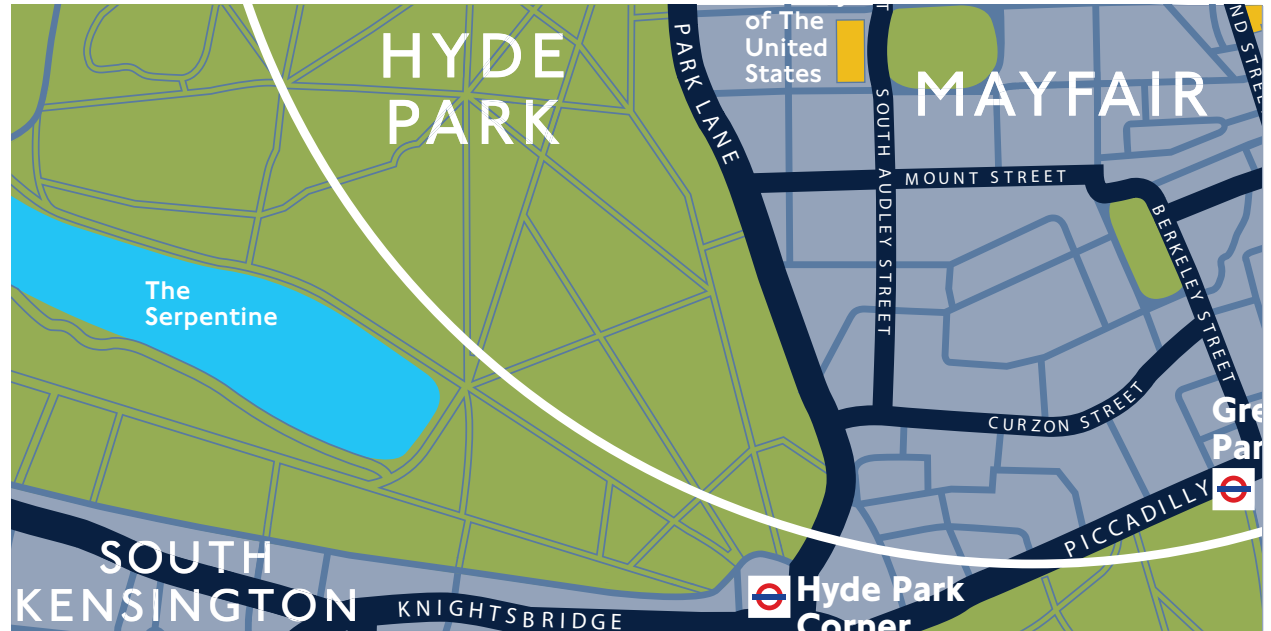

Example of two village name type sizes in use – South Kensington (18pt) and Hyde park (25pt)

Villages (primary size)

Size: 25pt
Leading: 25pt
Typeface: NJFont Light
Case: Upper
Tracking: +120
Alignment: Centred
Opacity: 80%
Colour: C0-M0-Y0-K0

Villages (secondary size)

Size: 18pt
Leading: 18pt
Typeface: NJFont Light
Case: Upper
Tracking: +120
Alignment: Centred
Opacity: 80%
Colour: C0-M0-Y0-K0

4.3 Roads

There are three types of roads shown on the planner map – primary, secondary and tertiary. The line weight and colour used for a particular road depends on its status within the preferred route network.

Road names are displayed in two different sizes, dependent on the status of road and the amount of space available. Only primary and secondary routes are labelled, with tertiary routes appearing without road names.

Where necessary, road names can be abbreviated as indicated in the appendix section of this document.

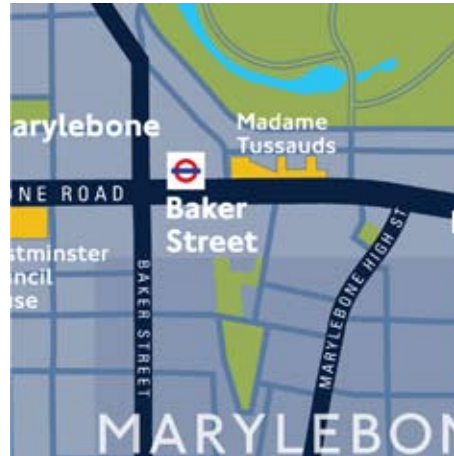

Major routes



Major routes (limited space) and secondary routes

Major routes
Weight: 11pt Colour: C87-M46-Y0-K81
Major routes label
Size: 8.5pt Typeface: Univers 57 Condensed Case: Upper Alignment: Centred Tracking: +150 Colour: C0-M0-Y0-K0
Secondary routes
Weight: 7.5pt Colour: C87-M46-Y0-K81
Secondary routes label
Size: 6.5pt Typeface: Univers 57 Condensed Case: Upper Alignment: Centred Tracking: +150 Colour: C0-M0-Y0-K0
Tertiary routes
Weight: 2.5pt Colour: C53-M27-Y0-K31

4.4 Landmark building labels

Contents



As a rule, only the top level landmarks are represented on the planner map.

As a result of this lower density of buildings, it should always be possible to position the corresponding label over the base and road colours, and not over the yellow buildings themselves. This aids legibility and removes the need to outline this type or use a different colour label.



Landmark labels

Size: 10pt

Leading: 10pt

Typeface: NJFont

Medium

Case: Upper & lower

Alignment: Left

Tracking: +20

Colour: C0-M0-Y0-K0

4.5 Green spaces

There are two categories of green spaces, each defined by a corresponding colour. One space being named 'woodland' and the other 'green areas'. Woodland refers to areas of forestation. 'Green areas' cover more general areas, ie: parks and garden squares.

There are two type styles that can be used when labelling green spaces on the planner map.

The majority should be labelled using a 10pt style similar to that of landmarks, shown above left.

However, in some instances large green spaces are also identified as villages. On these occasions, the larger village label is used and the 10pt generic label omitted.



Generic green spaces



Green spaces that are also villages

Green spaces
Size: 10pt
Leading: 10pt
Typeface: NJFont Medium
Case: Upper & lower
Tracking: +20
Alignment: Left
Green area colour: C40-M10-Y80-K10
Woodland colour: C55-M7-Y70-K15
Green spaces that are villages
Size: 25pt
Leading: 25pt
Typeface: NJFont Light
Case: Upper
Tracking: +120
Alignment: Centred
Opacity: 80%
Colour: C0-M0-Y0-K0

4.6 Areas of water

Areas of water are labelled using one of two type styles.

The majority should be labelled using a 10pt style similar to that of landmarks, shown above left.

However, the River Thames should be labelled in a style more akin to a village name, as shown.



Lake/Canals

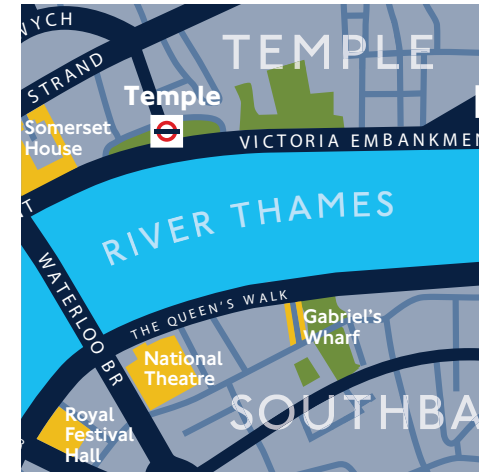

River Thames

Lakes/Canals
Size: 10pt
Leading: 10pt
Typeface: NJFont Medium
Case: Upper & lower
Tracking: +20
Alignment: Left
Colour: C0-M0-Y0-K0
River Thames
Size: 18pt
Leading: 18pt
Typeface: NJFont Light
Case: Upper
Tracking: +120
Alignment: Centred
Opacity: 80%
Colour: C0-M0-Y0-K0

4.7 Underground, Overground, DLR, London Buses and National Rail stations and National Rail stations

Underground, Overground, DLR, London Buses and National Rail stations should be indicated with a 5.5mm pictogram (or pictograms, dependent on services offered) and its name.

The 5.5mm pictogram (or pictograms) should act to show where the main entrance/cluster of entrances occurs.



1.5



1



1.5

Station names
Size: 12pt
Leading: 12pt
Typeface: NJFont Bold
Case: Upper & lower
Colour: C0-M0-Y0-K0

4.8 River piers

Contents



All primary piers are shown on TfL planner maps. Primary piers offer a level of service approved by TfL (contact TfL Corporate Design if in doubt as to whether a pier meets this criteria).

Primary piers are shown as a 3.5mm high boat pictogram on planner maps. Pier names are also shown.

Secondary piers are not to be shown on the planner map.

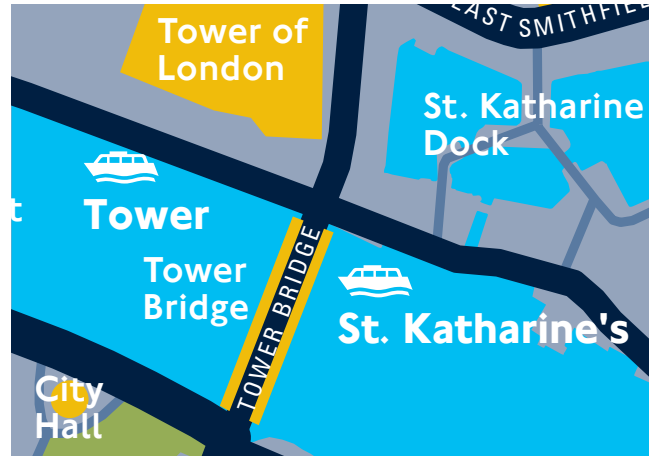

4.9 Walking circle and 'You are here' marker

Contents



The 'You are here' and '15 minute walking circle' identify where the user is and the approximate distance to featured destinations.

The 'You are here' marker is positioned with the horizontal bar above the arrow reflecting the location and orientation of the sign.

The walking circle is placed centrally over the sign position and should sit centrally within the map crop, therefore giving an unbiased view of what destinations are within 15 minutes of the user in their current location.



You are here marker
Size: 22pt
Typeface: NJFont
Medium
Case: Upper & lower
Alignment: Left
Colour: C0-M0-Y0-K0

Walking circle sits centrally within the planner map

4.9.1 Walking circle and 'You are here' marker (continued)

[Contents](#)



15min walking circle

Diameter: 222mm
Stroke weight: 3.25pt

Walking circle label

Size: 22pt
Typeface: NJFont
Medium
Case: Upper & lower
Alignment: Centred
Colour: C0-M0-Y0-K0

4.9.2 Walking circle and 'You are here' marker (continued)

The '15 minute walk' tab that is attached to the walking circle ranges left off the centre line of the circle, as the default preferred position, as shown above.

When this is not possible as a result of the map being congested with other elements, it should be ranged right off the centre line, as a second preferred option.

If neither of these two positions can be achieved it should be moved along the circle in either direction until an optimum position is achieved.

The 'You are here' marker also ranges off the centre line of the circle as shown above, and has four pre-defined versions to allow for optimised placement on congested areas of map. These are shown above, in order of preference.

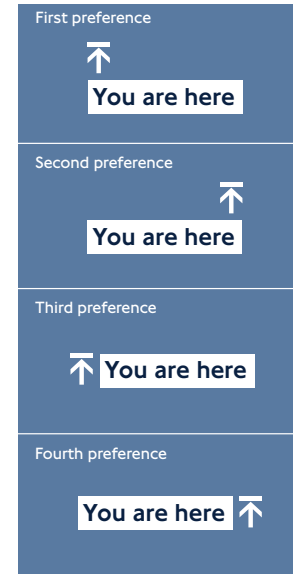

4.10 North indicator

A north indicator is included on the planner map to aid orientation and confirm the heads-up nature of the map.

It is placed in one of the four corners of the map – generally the corner with the least other map elements. Careful consideration should be given when placing the north indicator to avoid legibility issues between the north marker and any surrounding mapping elements

Examples are shown of how the north indicator should be positioned to sit comfortably in the corner, with visually equal margins around it, depending on its rotation.

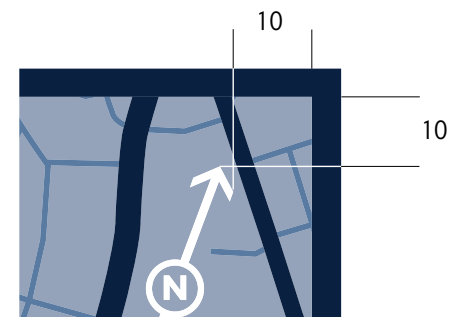

4.11 Unique sign code

Contents



A unique sign code is to be applied to each sign. The code is located alongside the planner map in the fixed position shown.

The code consists of five parts:

- 1 Two or three digit project prefix
- 2 Five digit unique code followed by slash (/)
- 3 Panel number
- 4 Face letter followed by slash (/)
- 5 Revision number



Unique sign code text

Size: 11pt
Typeface: NJFont Light
Vertical alignment:
Bottom of planner map
Horizontal alignment:
5.5mm from planner map
Colour: C26-MI3-Y0-K24

5 Third party usage

[Contents](#)



When producing maps to be used by third parties such as private organisations, the rules on the following pages must be observed.

5.1 Highlighting selected buildings

[Contents](#)



Where a particular building is to be highlighted, it should be displayed using the 3D building rules described earlier in this document. All other buildings should be displayed as standard landmark buildings.

5.2 Highlighting multiple locations on a map

Contents



When it is necessary to highlight multiple locations on a map, the numbered circle device is to be used. The circle is to be displayed in purple, C-50, M-100, and the digits in white.

Digits are always vertically and horizontally centred within the 6mm diameter circle. Digits are displayed in New Johnston Medium 12pt.

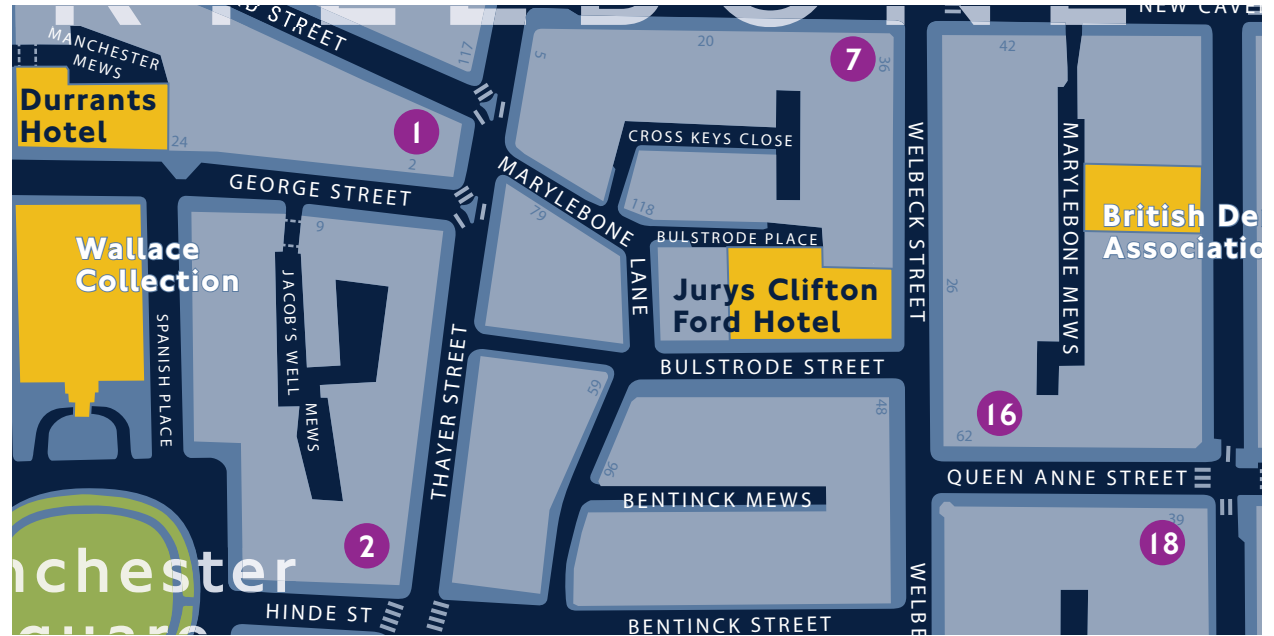

5.3 Highlighting selected routes

Walking routes that require highlighting should only be displayed on the Planner map. All routes are to be highlighted in yellow, M22-Y100-K6, using a 5.5pt line centred on pedestrian paths and roads. Road names on walking routes are displayed in dark blue, C87-M46-K81.

Where routes run on roads, the road is always shown beneath at a weight of 7.5pt (a secondary road width).

Route lines are never broken and road names are to sit on the road network as normal. Where possible, road names should be moved so as not to overlay both the road colour and the route colour at the same time.

Where routes diverge to show an option of following an accessible route, they must be marked clearly, identifying the decision point and making reference to the obstacle ahead. This must then also be referenced in the off-map pointer of the route if necessary.

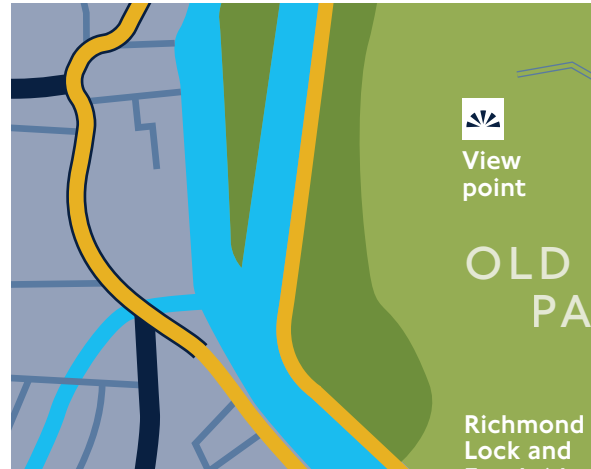

Shared and segregated routes



Road names

5.4 Walking scale

Contents



On third party printed material only, a walking scale may be shown in place of the walking circle.

The construction of the tab to accompany the scale is shown here.

On hoardings, because the location is fixed and a 'You are here' identifier is displayed, then it is only the walking circle that is to be used.



5.5 Branding maps on third party material



Each map is to be issued endorsed with the TfL branding strip at the bottom, a registration number and copyright information.

The position of these elements are fixed and are not to be altered.

The wording for the copyright information is as follows: © Crown copyright and database rights 2011 Ordnance Survey 100035971

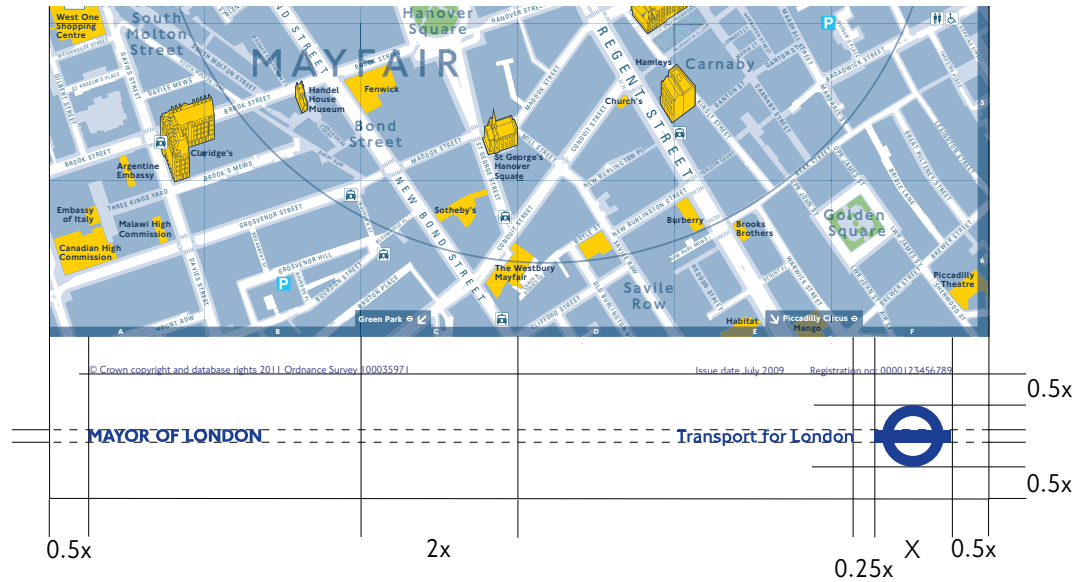



For further information:

In case of difficulty or doubt as to the correctness in the application of these standards, please contact TfL Corporate Design.

Telephone: **020 7126 1624**

Internal extension: **61624**

Email: **corporatedesign@tfl.gov.uk**

All TfL corporate design standards are available from the TfL internet site.

tfl.gov.uk/corporatedesign

Issue 2, August 2011

© Transport for London